



ADVENTURE *Pro*



Owner's Manual

Safety Information.

The Yamaha Adventure Pro powered by Magellan is an Off-Highway recreational vehicle navigation aid designed to assist you in driving on your off-road routes and identifying or navigating to selected destinations. The system is also capable as a navigation aid on public streets, roads or highways for use in street-legal vehicles.

Before using this device, please check with your state or local law enforcement for any applicable regulations regarding its use. It's your responsibility to comply with all traffic laws and other regulations. Be sure to read this guide as well as the owner's/operator's manuals for any vehicle in which you will use this device.

The driver or passenger should enter data or program the Adventure Pro receiver only when the vehicle is stopped.

Every attempt is made to ensure the database is accurate. However, trails, terrain, roadways, points of interest (POIs), and business and service locations may change over time.

Keep the receiver safe from extreme temperature conditions. For example, do not leave it exposed to direct sunlight for an extended period of time. The maximum operating temperature is 140°F (60°C).

Take care when mounting the receiver on your vehicle. Read an assembly manual regarding proper mounting methods for each designated Yamaha ATV or Side-by-Side vehicles. When you use this system on other vehicles, take extra care, whether using the windshield mount or other mount or accessories, that it does not obstruct the driver's view of the road, interfere with the operation of the vehicle's safety devices such as airbags, or present a hazard to occupants of the vehicle should the receiver be dislodged while driving.

You assume the risks associated with the damage to your vehicle or vehicle occupants as the result of your choices in mounting the receiver.

The battery is rechargeable and should not be removed. In the event it should need to be replaced, please contact a Yamaha Dealer.

All Magellan global positioning system (GPS) receivers are navigation aids, and are not intended to replace other methods of navigation. The customer is advised to perform careful position charting and use good judgment. **READ THE OWNER'S MANUAL CAREFULLY BEFORE USING THE PRODUCT.**

FCC RF Radiation Exposure Statement

1. This transmitter must not be co-located or operating in conjunction with any other antenna or transmitter.
2. This equipment complies with FCC RF radiation exposure limits set forth for an uncontrolled environment. This equipment should be installed and operated with a minimum distance of 20 centimeters between the radiator and your body.

Wi-Fi 5G Band 1 is for indoor use only.

USA use only

This device is designed to be used throughout the United States.

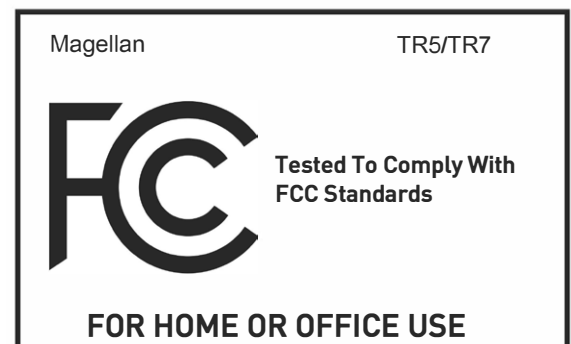

Table of Contents.

SAFETY INFORMATION.....	04	LOGS.....	17
HARDWARE	06	Definition: Tracks	17
GPS & Cradle Overview	06	Track Details	17
Accessories Overview.....	07	Expand/Contract Map View	17
Mounting to a Yamaha Vehicle	08	Following a Track	17
Battery/Power in your Vehicle.....	09	Share a Track	18
Battery/Power Outside of your Vehicle	10	Save Satellite Map.....	18
GETTING STARTED	11	Create a Course from a Track.....	18
End User License Agreement	11	Edit a Track.....	18
Wi-Fi Network Setup.....	11	Create a New Trip Folder	19
Skip Wi-Fi Setup.....	11	Add Entries to a Trip Folder	19
Add Wi-Fi Network.....	11	Share a Trip Folder.....	19
Forget Network	11	Import GPS Files	19,20
Refresh Wi-Fi Networks.....	11	Export GPS Files.....	20
Updates	12	Delete Items from Logs.....	20
Create Account	13	PLANS	21
Sign In.....	13	Definition: Trails	21
Product Registration	13	Definition: Shared Tracks.....	21
Reset Password.....	13	Definition: Custom Routes	21
DASHBOARD.....	14	Delete Items from Plans	21
Dashboard Overview.....	14	SEARCH	22
Menu Bar	14	Search Categories.....	22
Yamaha Instruments	15	Set Search Location	22
Change Dashboard Instruments.....	15	Search Location/Near City or Zip.....	22
JOURNAL.....	16	Search Location/Near Point on Map.....	23
Journal Overview.....	16	Search Location/Near Coordinates	23
Logs	16	Search Results/List View	23
Plans.....	16	Search Results/Map View	23
Sort by	16	Search Results/Info.....	24

Table of Contents.

Search Results/Save	24	Follow a Trail	33
Search Results/Share	24	Follow a Track	33
Search Results/Follow/Go	24	Follow a Custom Route	34
MAP & NAVIGATION	25	Waypoint Alerts	34
Map Screen Overview	25	Off-Track Alerts	34
Panning the Map	26	TIMING MODE	35
Map Zoom	26	Create a New Course	36
Select a Point on Map	26	Loop Course	36
Map Options	27	Sprint Course	36
Switch the Basemap	27	Course Waypoints	36
Switch 2D/3D Views	27	Start a New Session	37
Additional Map Options	27	Laps	37
Satellite Imagery Subscription	28	Runs	37
Save Satellite Map	28	Finish a Session	37
Satellite Imagery Size and Daily Limits	28	Session History	38
Waypoints	29	Clear History	38
Quick Waypoints	29	Review Laps and Vehicle Data	38
Detail Waypoints	29	Session Sharing	38
Waypoint Types	29	SETTINGS	39
Audio Waypoints	30	Open Android	39
Set Waypoint at Current Location	30	Updates	39
Set Waypoint at Point on Map	30	Manual Sync	39
Set Waypoint at Coordinates	30	Account Profile/Create Account	39
Record a Track	31	Account Profile/Product Registration	40
Pause Tracking	31	Account Profile/Sign In	40
Resume Tracking	31	Vehicle Profiles	40
Backtrack to Start	31	Social Networks	40
Finish and Save a Track	32	Link to Twitter	41
Street Navigation	32	Link to Instagram	41

Table of Contents.

- Link to Facebook41
- Achievements41
- General.....42
- Support.....42
- Map Display42
- Navigation.....42
- Map Save43
- Service Alerts43
- History44
- Wi-Fi44
- Product Information.....44
- CAMERA 45**
- Open Android.....45
- Open the Camera App45
- Open Camera Settings45
- Camera Settings.....45
- Taking Photos46
- Taking Videos.....46
- View Photos & Videos.....46

Hardware.

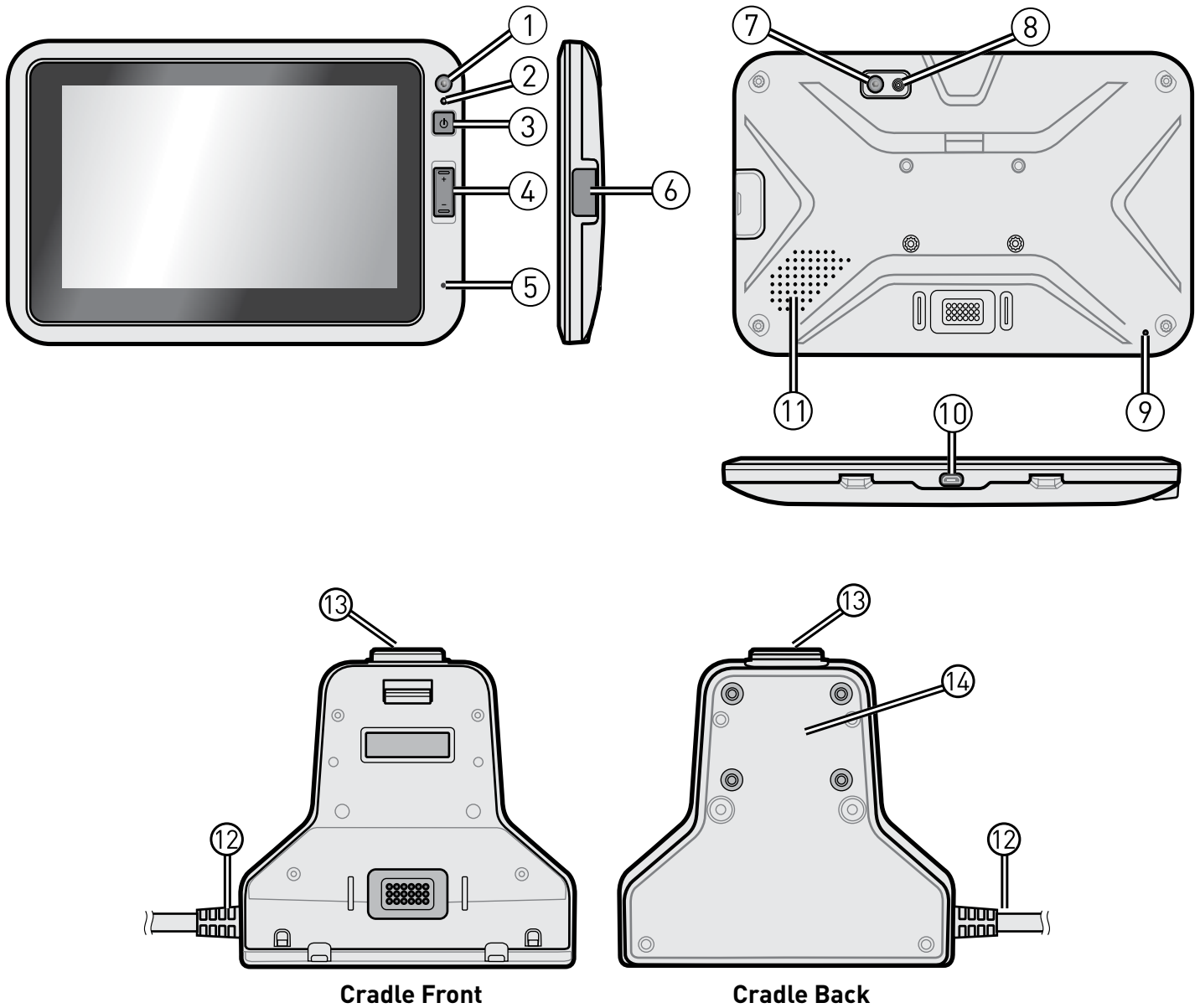

1. Front camera lens
2. Light sensor
3. POWER button
4. Volume buttons (+ / -)
5. Front microphone
6. microSD card slot

9. Rear microphone
10. Mini-USB port
11. Speaker
12. CAN Bus harness connector
13. Quick release button
14. AMPS mounting

Hardware.



1. Adventure Pro GPS Navigator
2. Vehicle power adapter
3. AC power adapter
4. micro USB Cord

5. Adventure Pro cradle with Can-bus harness
6. RAM Torque™ mount
7. RAM sizing inserts
8. Hex key



Hardware.



ATTACH MOUNT TO YAMAHA VEHICLE

- Using the supplied allen tool attach the torque ring to the passenger grab bar.
- Attach the mount arm to the torque ring
- Attach the mount base plate to the GPS cradle



CONNECT CRADLE TO MOUNT

- With the RAM mount base plate attached to the GPS cradle connect the ball joint into the mount arm



CONNECT CRADLE HARNESS TO VEHICLE

Push the male-end 4pin connector into the 4pin receptacle



CONNECT GPS TO CRADLE

The GPS sits in the cradle and will snap into place. To remove the GPS press the button at the top of the cradle to release it.

Hardware.



Powering on with the vehicle

When properly connected to your Yamaha ATV or Side-by-Side vehicle the Adventure Pro GPS navigation system will power on when the vehicle is keyed on.

1. Make sure the Adventure Pro GPS navigation system is properly attached to the power cradle.
2. Insert the vehicle key and turn the key to power on the vehicle

Powering off with the vehicle

When the vehicle is turned off the GPS will stay in a suspended state with the screen OFF. While in suspend mode the GPS will only use the internal battery power that can last up to 4 days* from a fully charged state. If the vehicle is powered on within that time frame the GPS will boot up immediately with the vehicle.

* When the internal battery level drops to 30%, the GPS will power itself off fully. This will help to make sure there is enough battery power to turn the GPS back on within the standard 1 minute "cold" boot time.

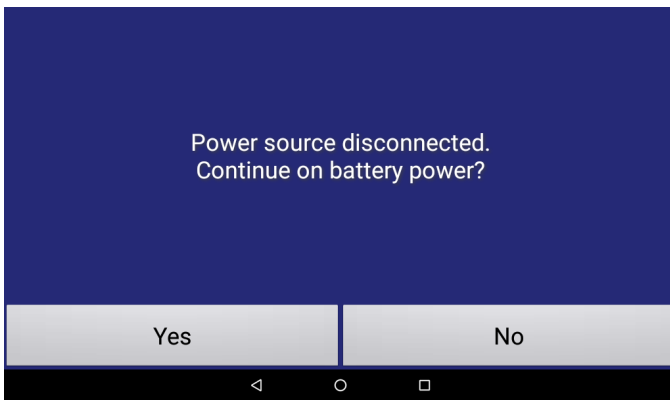

Your Adventure Pro GPS navigation system can be removed from the vehicle cradle and used on internal battery power. The internal lithium ion battery is 2400mAH and has a battery life up to 4 days or 96 hrs from a full charge.

Disconnecting from Vehicle Power

When the vehicle is turned off or the GPS is removed from its cradle, you will be prompted with a message saying, "Power source disconnected. Continue on Battery power?" If you touch "Yes" the GPS will remain on using its internal battery. If you touch "NO" or wait 20 seconds, the device will go to sleep until it reaches 30% battery life remaining. You can resume activity by pressing any button, tapping the screen or reconnecting the GPS to your vehicle and turning the vehicle power ON. If you want to cut GPS completely off hold the red button until shutdown begins.

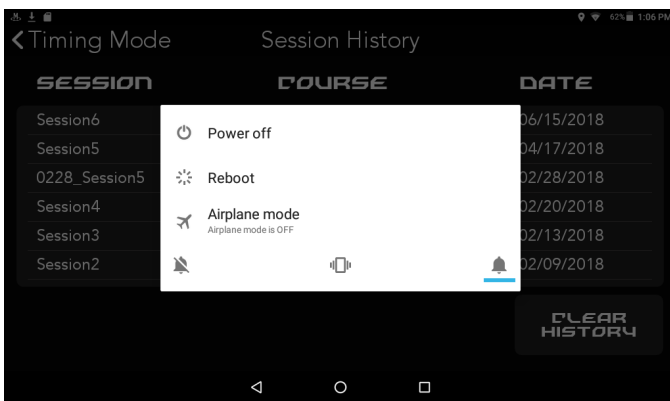

Power On

Press and hold the red power button the front right-hand side of the GPS. Starting from a fully powered off state, the GPS will take up to 1 min to boot up and open to the Adventure Pro dashboard.

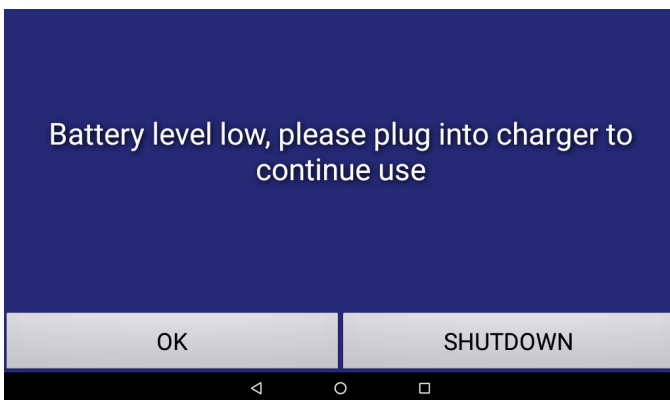

Manual Shutdown

At any time the GPS is on press and hold the red power button to shutdown the GPS. Choose to Power off, Reboot or turn on/off Airplane Mode.

Suspend Mode

At any time the GPS is on, quickly press and release the red power button on the front right-hand side of the GPS. The screen turn off, but the GPS is still on. The GPS will stay in suspend mode until it reaches 30% battery life remaining. You can resume activity by pressing any button, tapping the screen or reconnecting the GPS to your vehicle and turning the vehicle power ON.

Low Battery

If the GPS is ON but not connected to an external power source and the battery level reaches 30%, you will be notified the battery level is low. Choose whether to continue using the GPS or to shutdown.

Getting Started.

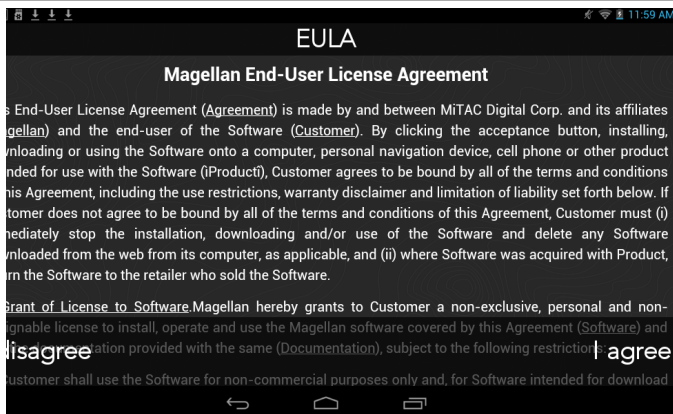

The first time you use your new Adventure Pro system you will be asked to:

1. Review and agree to the End User License Agreement.
2. Set up a Wi-Fi network connection.
3. Set up a new user account and register your GPS.

Magellan End-User License Agreement (EULA)

The Yamaha Adventure Pro software is designed and developed by Magellan GPS. Please review and select “I Agree” to accept the EULA and proceed with setting up and using your GPS.



Wi-Fi Network Setup

1. Select your preferred Wi-Fi from the list of available networks.
2. Enter Wi-Fi password (if applicable) > tap Connect.
3. Select Next to continue.

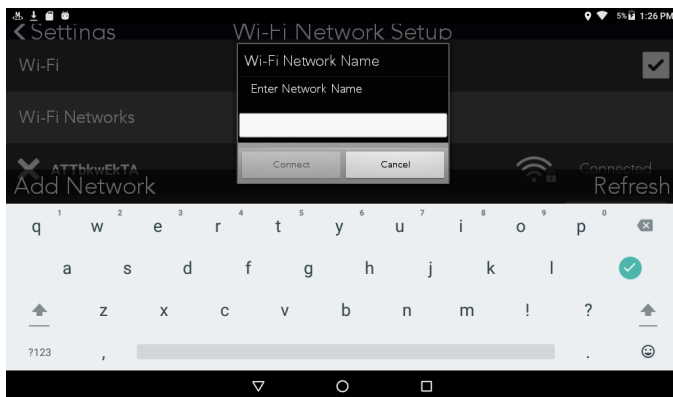

Skip Wi-Fi Setup

Setting up a Wi-Fi connection is optional and not mandatory to use the GPS. If you are not within range of a Wi-Fi network, or do not wish to connect to Wi-Fi at the current time, you can choose **Skip**. You can choose to connect to Wi-Fi at any time in the future by going into the Adventure Pro Settings and selecting Wi-Fi.



Add Network

1. Add the Wi-Fi network name.
2. Select the security level for the network.

Forget Network

1. Select the X next to the network name.
2. Select OK or Cancel to forget the network.

Refresh

Select **Refresh** to refresh the list of available Wi-Fi networks currently in range of the GPS.

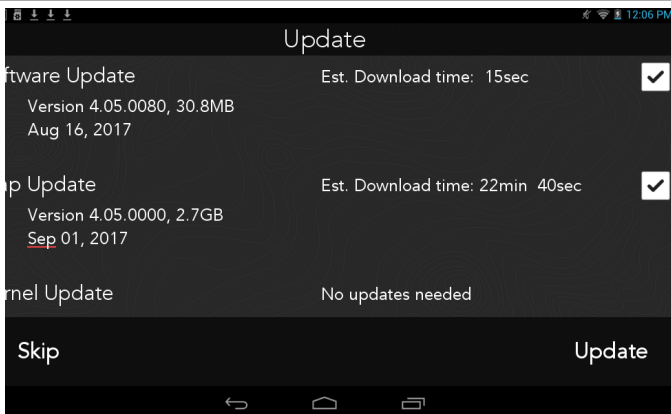

UPDATE SOFTWARE & MAPS.

Note: Wi-Fi must be **ON** to get updates. You must also have a good Internet connection to complete updates. The update screen will tell you if there is an available software, map and/or kernel update. It will tell you the version, brief description and the estimated download time based on your Wi-Fi connection.

1. Check the boxes for the updates you wish to download and install, or press **Skip** to optionally skip the updates and do them later.
2. Press **Update** button at the bottom right.

SOFTWARE UPDATES

You will see a progress bar across the bottom of the Updates screen as the software update downloads. When you are notified the download is complete press **Install**. The Adventure Pro software will close and you will follow the Android installation steps

Once the software update is installed, the Adventure Pro software will reopen and ask you to download Resources. Click **Start Download**.

MAP UPDATES

You will see a progress bar across the bottom of the Updates screen as the map update downloads. When you are notified the update is complete, click **OK**.

NO UPDATES

If there are no updates available, the options will be grayed out and show the word "Current", meaning your software, map and kernel on your GPS are the most current versions.

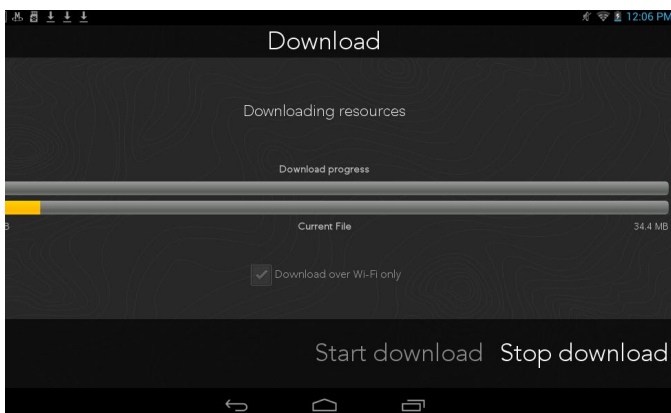

Getting Started.

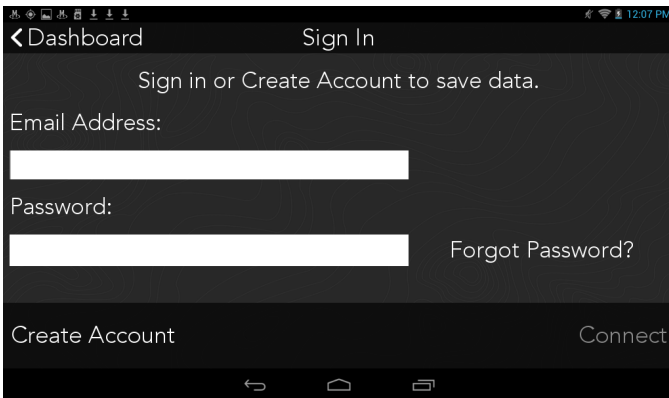

CREATE ACCOUNT

If you are a new user and have not created an account previously, choose this option in the bottom left of the Sign in screen.

Note: you must be connected to a Wi-Fi network to create an account. You do not have to create an account in order to use your Yamaha Adventure Pro, but it is recommended.

On the Create Account page, you will be asked to enter an email address and password to create your new account. Your password must be at least six characters long. You may optionally enter a user name, your real name, city and state.

Click Create Account. You will see a blue bar notifying you the device is being registered, and will see a confirmation message "Account creation and device registration successful." Click OK. Your Yamaha Adventure Pro GPS will restart itself following account creation.

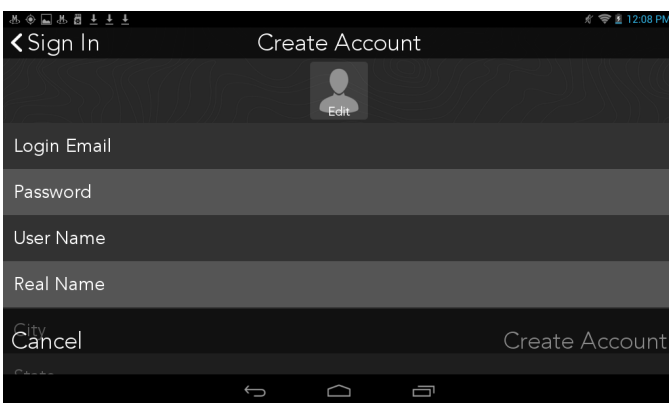

SIGN IN

Make sure you are connected to a Wi-Fi network before attempting to sign in. Enter your email address and password and click connect. Your Yamaha Adventure Pro GPS will restart following a successful sign on.

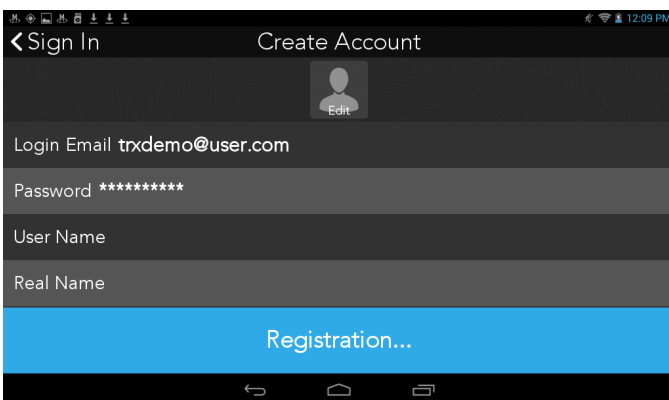

REGISTRATION

GPS registration is done automatically the first time you create an account on your Yamaha Adventure Pro.

RESET PASSWORD

Select reset password, enter the email address used for the account and click submit.

A reset password email will be sent to the email address provided with a link to reset your password on YamahaAdventurePro.com

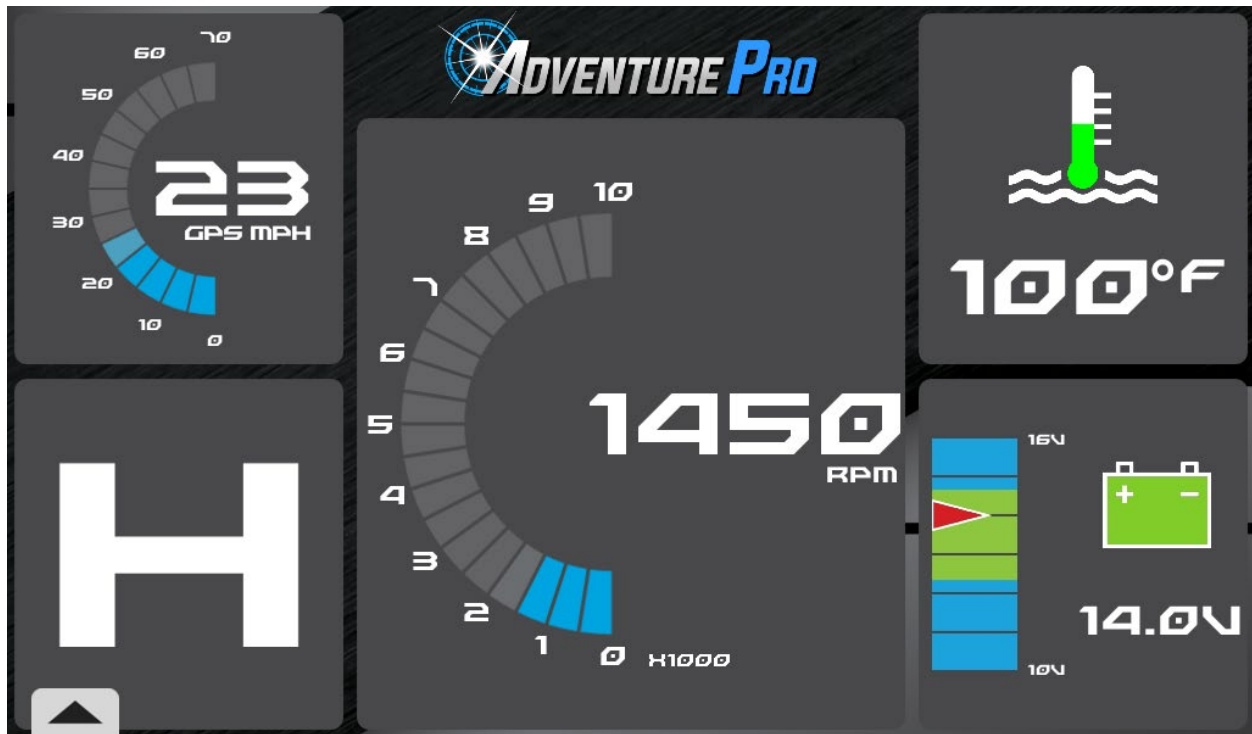

DASHBOARD OVERVIEW

Your Yamaha Adventure Pro will always start and open on the dashboard. The dashboard displays five default instruments. The dashboard layout is customizable. To change an instrument, press and hold the instrument you want to change. A menu of optional instruments will appear. Select the instrument to replace the selection.

All Yamaha instruments actively display data feeds from the vehicle. If you are not connected to the vehicle the instruments will read N/A (not available).

MENU BAR

The menu bar gives quick access to various areas of the software (see options on the right). The menu bar will hide automatically after a few seconds. Tap the menu tab to raise the menu and make your selection.



Journal: Contains your Log & Plans.



Search: Search for Trails, Tracks, POIs, etc.



Map: Open Map Screen.



Timing Mode: Create Courses, establish Lap Times, review your histories.



Dashboard: Return directly to the Dashboard from any display.



Settings: Edit Account, Vehicle Profiles, Connectivity, etc.

Dashboard.

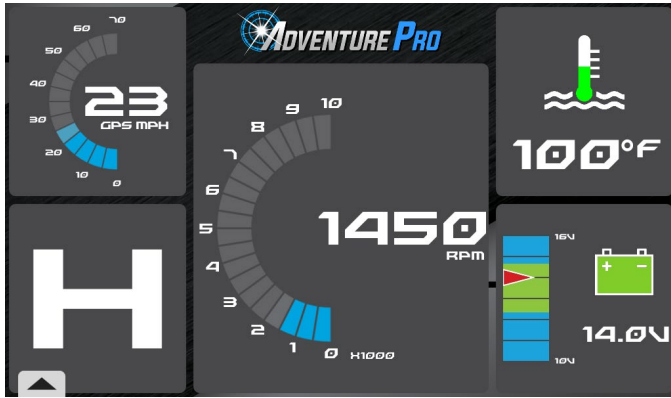

YAMAHA INSTRUMENTS

Yamaha instruments are designed to be used when connected to your Yamaha vehicle. The instruments receive and display data from your vehicle's on-board computer and sensors.

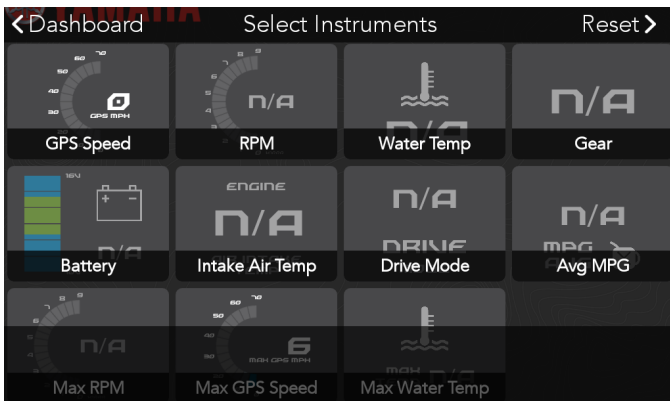

CHANGE DASHBOARD INSTRUMENTS

To change any of the five default dashboard instruments press/hold on the instrument(s) you want to change.

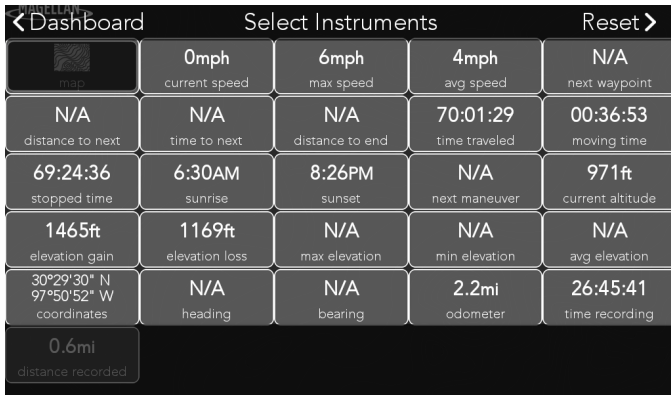

The instruments selection window will open.

Press/hold on any instrument to replace the originally selected instrument from your dashboard.

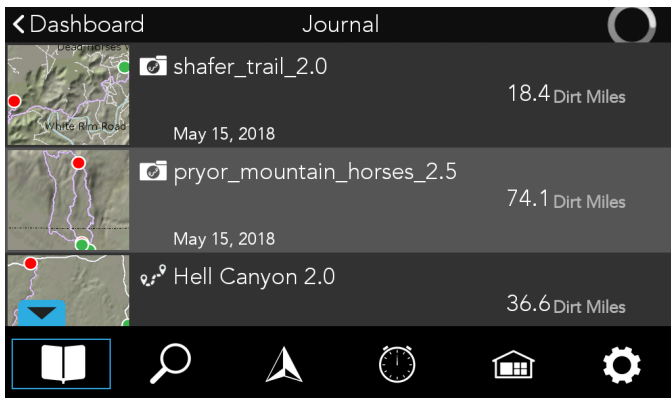

JOURNAL OVERVIEW

The Journal is where your GPS track recordings, waypoints and saved searches are stored.

There are two parts to the Journal: Logs and Plans.

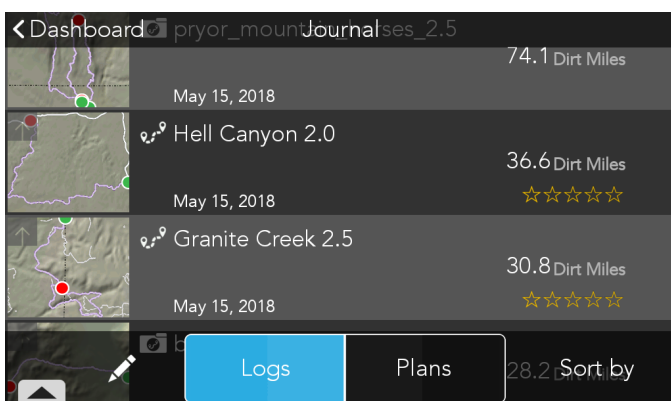

JOURNAL/LOGS

Logs contain Personal Tracks, Waypoints and Trip Folders

The Logs section of the Journal stores all of your GPS track recordings and waypoints. You can also create Trip Folders for organization and import and export GPS files.

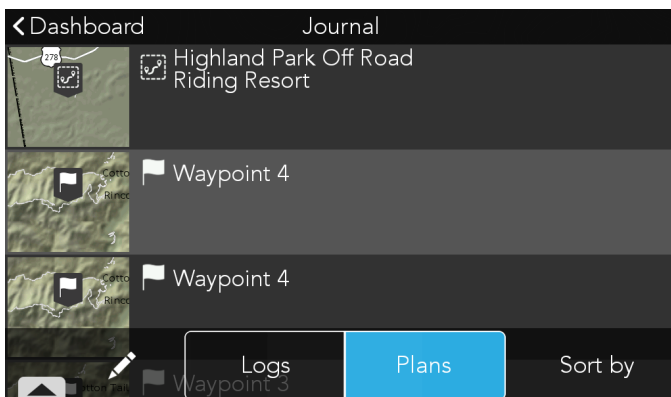

JOURNAL/PLANS

The Plans section of the Journal stores all of your saved searches and any custom routes created on YamahaAdventurePro.com using the Route Builder tool.

Plans can store Trails, Routes, POI, User Shared Tracks and User Shared Trip Folders.

You can select items from your Plans to Go to or Follow.

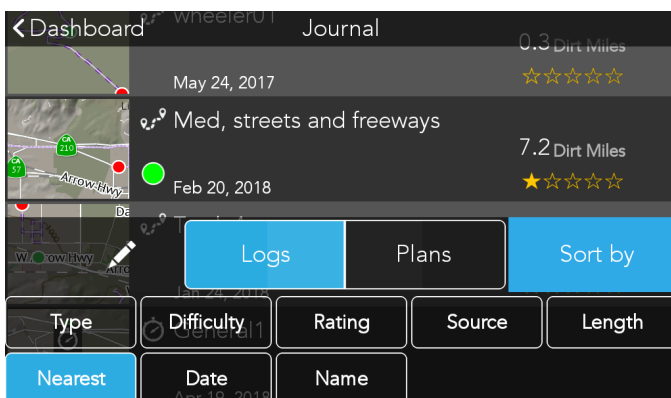

SORT BY

Press the SORT BY button to open the sort menu.

Choose to sort your Logs or Plans by Type, Difficulty, Rating, Source, Length, Nearby (Default), Date or Name

Press the SORT BY button again to hide the sort menu.

Log.

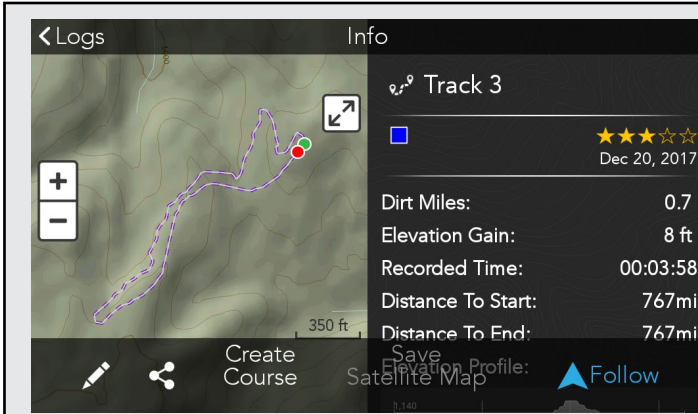

TRACKS

Tracks are your recorded GPS paths saved to your Log. Tracks can contain waypoints saved along the Active Track.

ON THE MAP:

Dashed purple line 

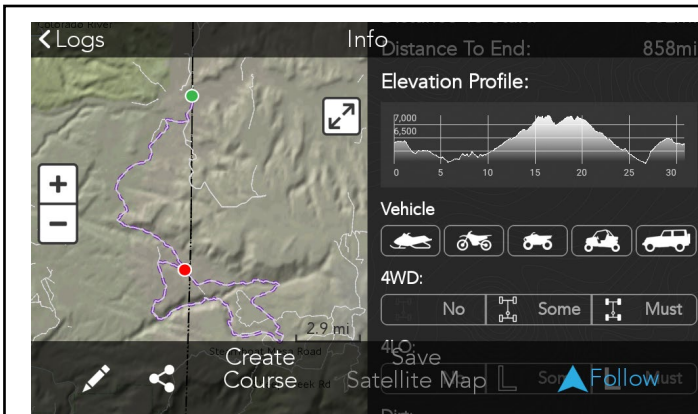

TRACK DETAILS

On the left-hand side of the screen the track details show a map preview of the full extent of the track file, the trail-heads and any waypoints attached to the track.

On the right-hand side of the screen you can view information and attributes about the track recording.

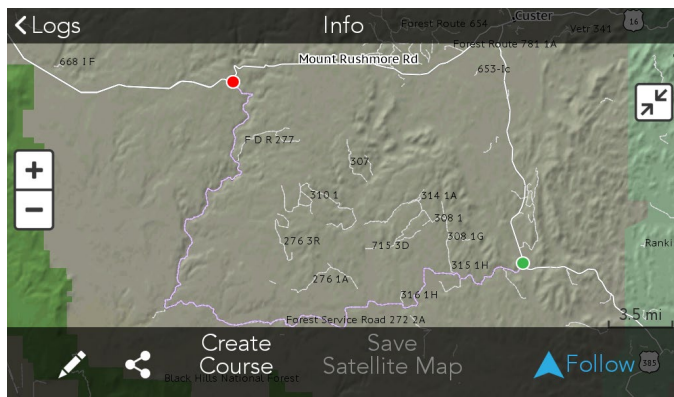

EXPAND/CONTRACT MAP VIEW

Press the Map View button to expand the map to full screen. From the full screen preview select the Map View button to contract the map again.

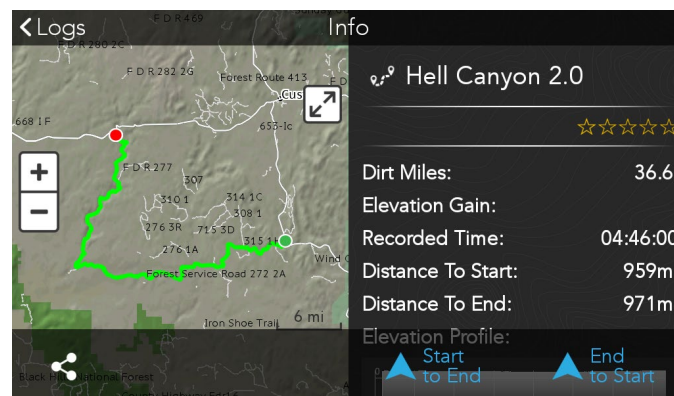

FOLLOW A TRACK

Press the FOLLOW button to follow a track from your Logs.

The track will be highlighted in green with a yellow guidance arrow leading the way. Any waypoints attached to the track will pop-up in advance notifying you of the objects that are coming up ahead.

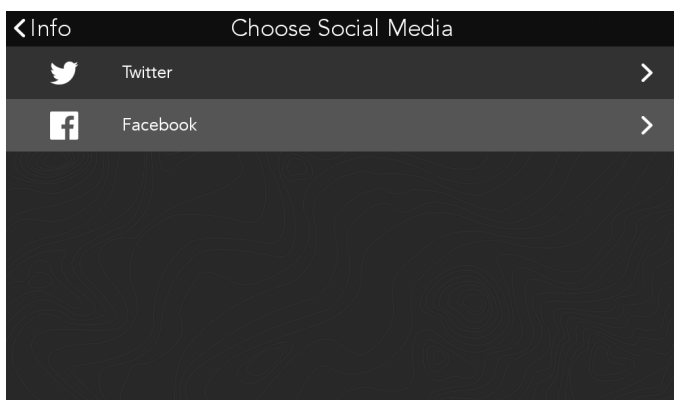

SHARE A TRACK

Make sure you are connected to Wi-Fi and press the SHARE button to share your data on connected social networks such as Twitter or Facebook.

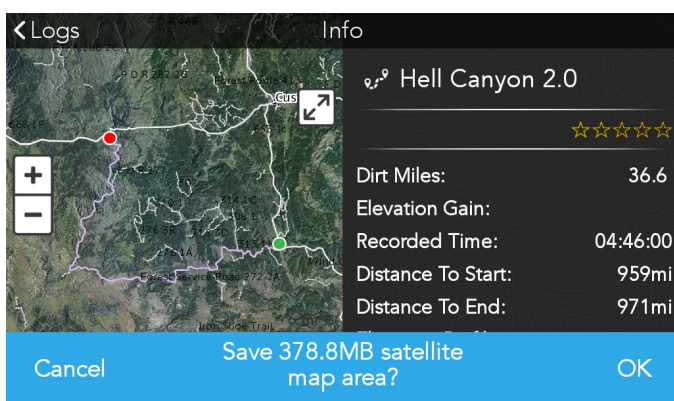

SAVE SATELLITE MAP

If you have an active Satellite Imagery subscription you can press Save Satellite Map to download the Satellite Imagery for the area surrounding that track.

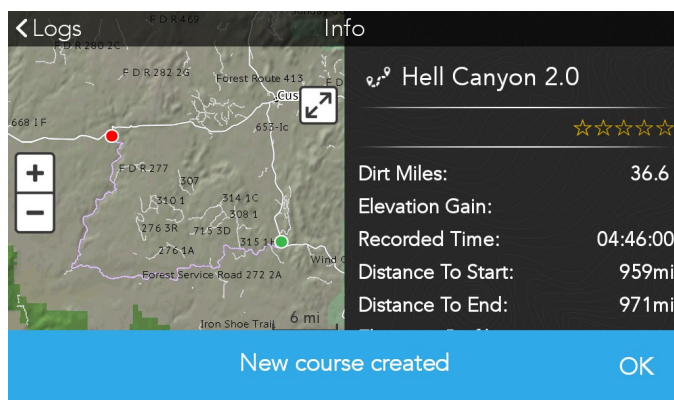

CREATE COURSE FROM A TRACK

Press Create Course to convert a track into a course to record new sessions in timing mode.

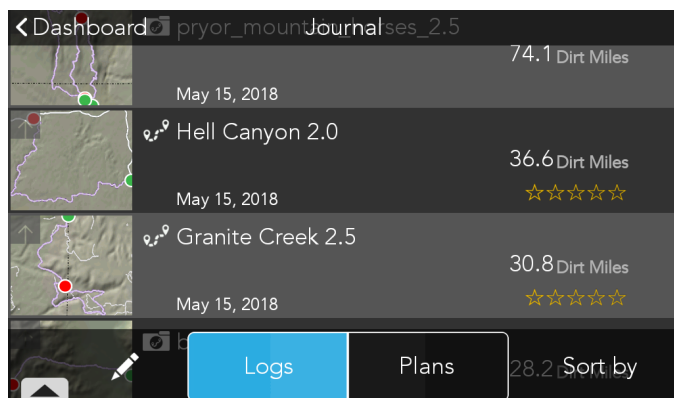

EDIT A TRACK

Press  to open the Log edit options.

Choose to Add a Trip Folder, Import or Export GPX files or delete items from your Logs.

Log.

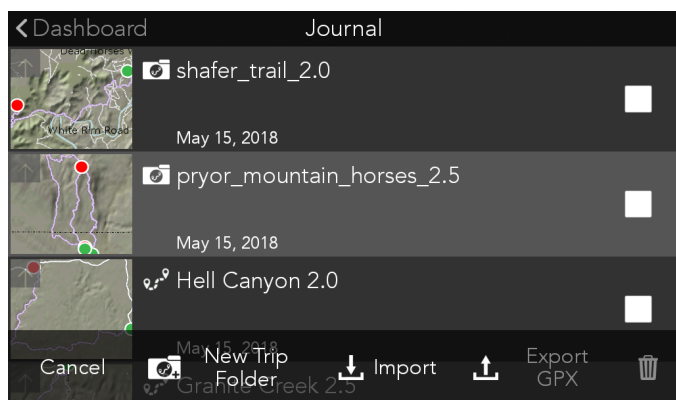

CREATE A NEW TRIP FOLDER

Press  to open the Log edit options.

Press .

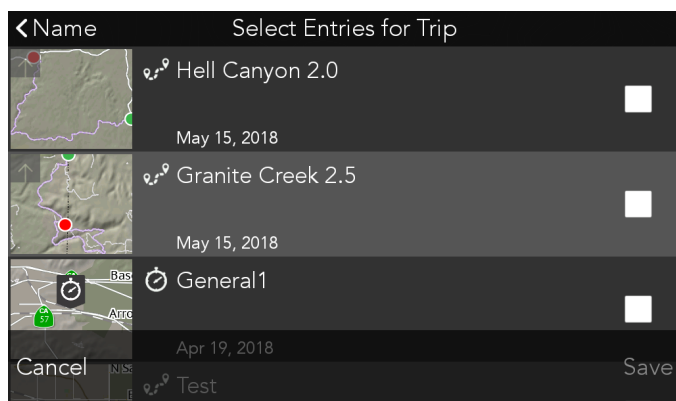

ADD ENTRIES TO A TRIP FOLDER

Select Add Entries to select the items from your Log you want to put into the trip folder. Items are copied into the folder, creating a duplicate of the original.

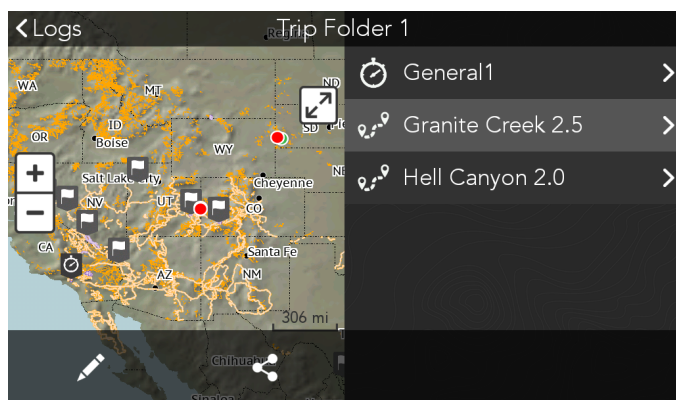

SHARE A TRIP FOLDER

A Trip Folder allows you to organize your tracks and waypoints into a folder for easy reference.

Select any waypoint or track in the Trip Folder to view the detailed information for that item.

Press  to add entries to this trip folder or to delete items from a trip folder.

Press  to share the trip folder.

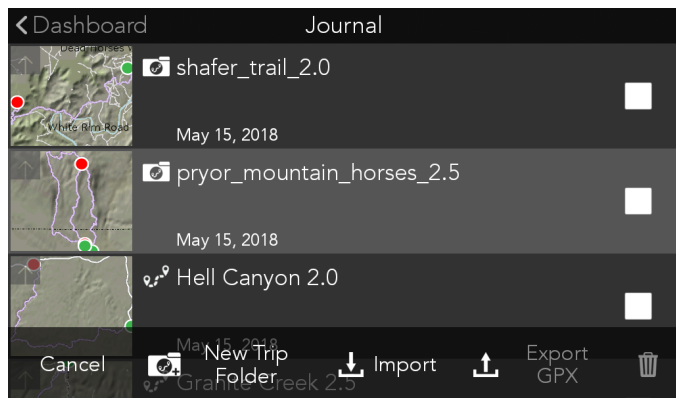

IMPORT GPS FILES

Press  to open the Log edit options.

Press .

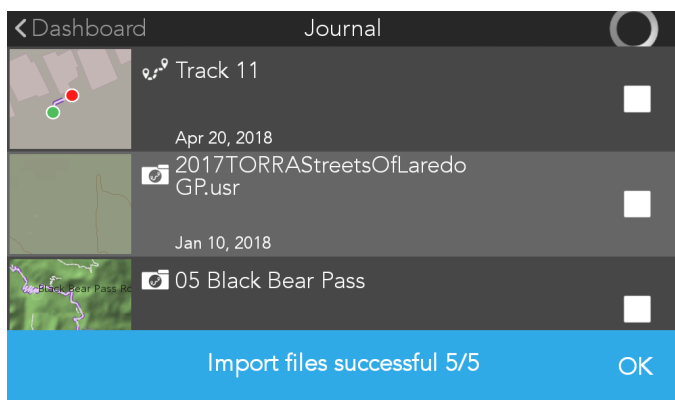

IMPORT GPS FILES

You can import GPX or USR file types from internal storage or from a microSD card.

Select the origin and choose the file(s) to be imported. Select **IMPORT**. The files will be added into a folder in your Logs.

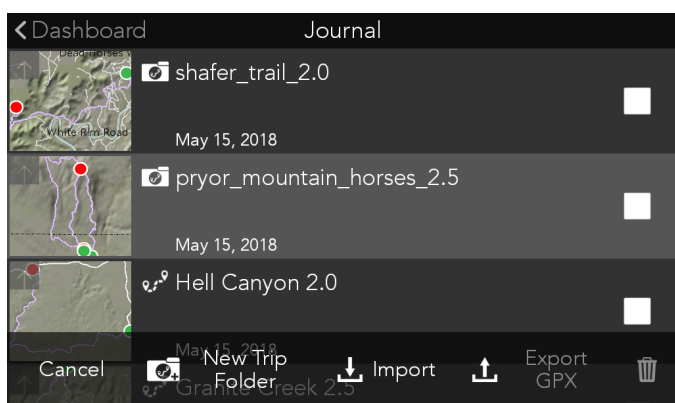

EXPORT GPX FILES

Press to open the Log edit options.

Press .

You must have a microSD card inserted in order to export files.

You can export your tracks and waypoints from your Logs as GPX file type. Select the items from your Logs to be exported.

All selected items will be exported into a single GPX or you can export one item at a time for individual GPX files. Make your selection and press **EXPORT**.

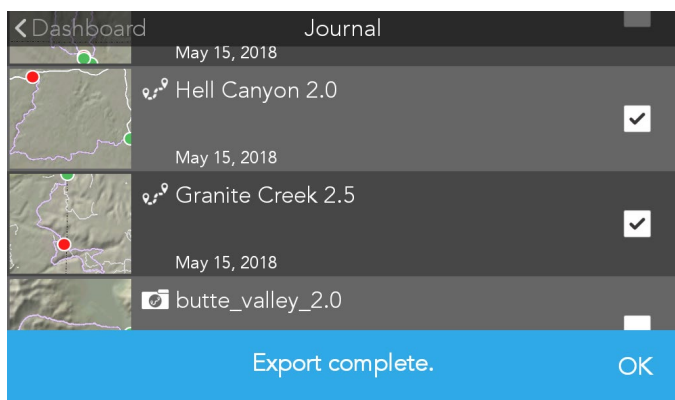

DELETE ITEMS FROM LOGS

Press to open the Log edit options and select .

Check the items in the Logs list you want to delete and press .

Select **OK** or **Cancel** to finalize your choice.

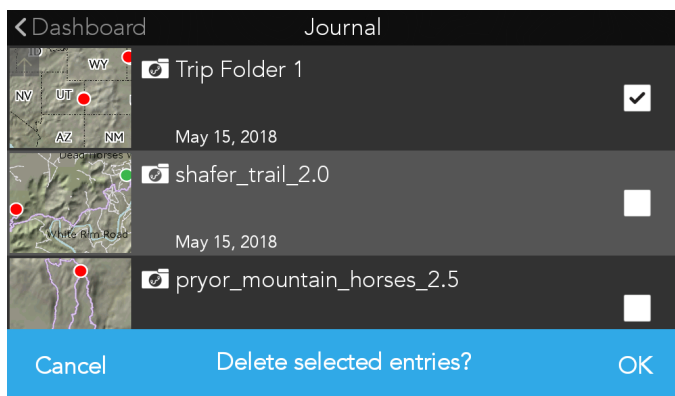

Plans.

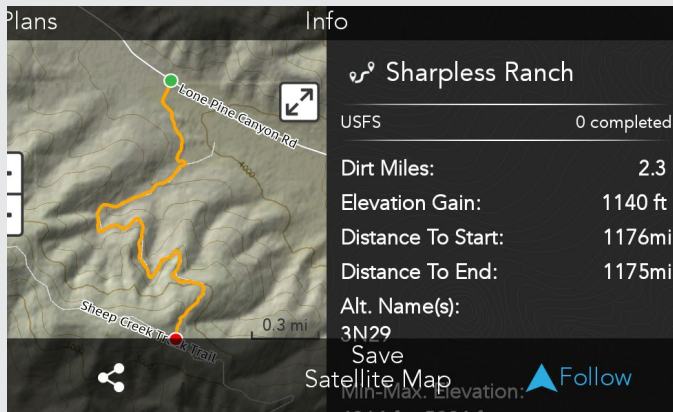

TRAILS

Trails are the official record from the authority that manages the land or trail system. Trails found on the map or through search can be saved to your Plans folder for future use.

ON THE MAP:

Solid orange line 

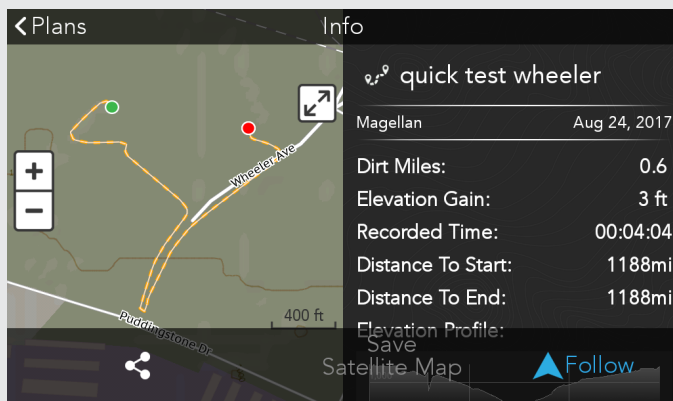

SHARED TRACKS

Shared tracks are tracks recorded by other Yamaha Adventure Pro or Magellan TRX users and published for all OHV enthusiasts to use. Shared tracks are helpful but should always be used with extreme caution.

ON THE MAP:

Dashed orange line 

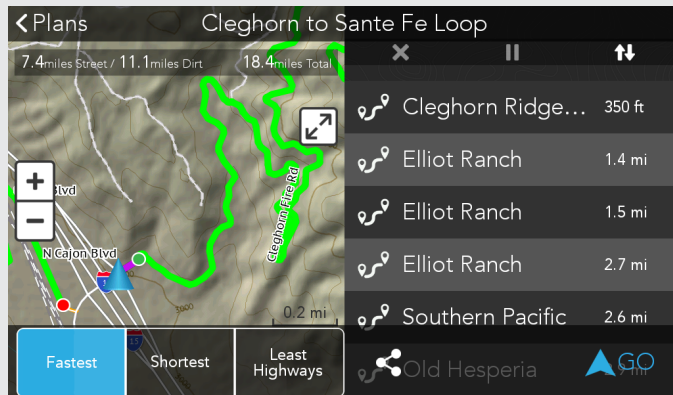

CUSTOM ROUTES

Using your Yamaha Adventure Pro account you can log in to YamahaAdventurePro.com and create custom routes on selected trails and then sync that route to your GPS.

ON THE MAP:

Dashed purple line 

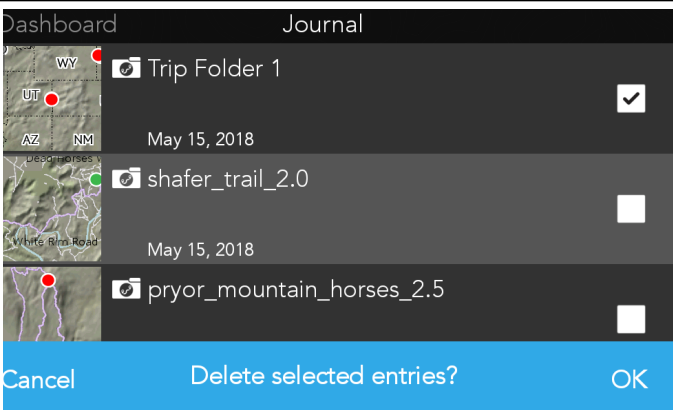

DELETE ITEMS FROM PLANS

Press  to open the Plans edit options and select .

Check the items in the Plans list to be deleted and press .

Select **OK** or **Cancel** to finalize your choice.

SEARCH

Enter keywords, an address and/or select a category to search for. You can also set a specific location to search around.

SEARCH CATEGORIES

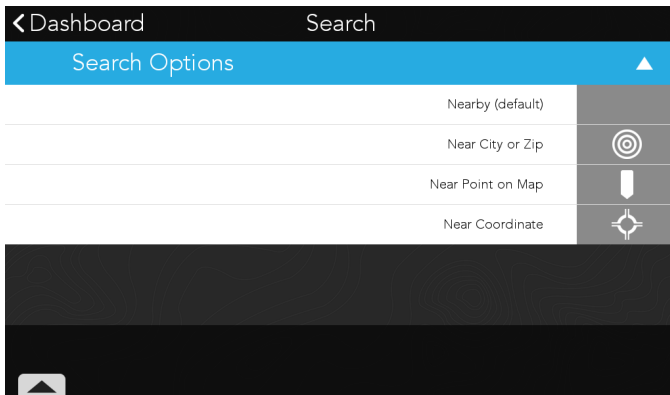
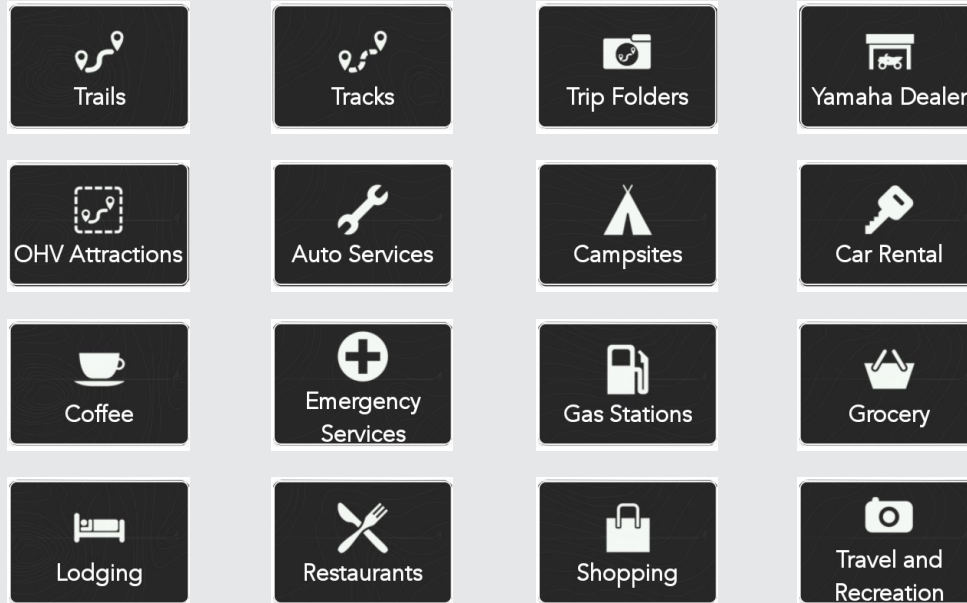

SET SEARCH LOCATION

By default your GPS will search around your current location (Nearby). You can change it to the location you want to search around.

On the Search screen, press the **Nearby** button in the top right of the screen and select from the options to enter a new location for your search.

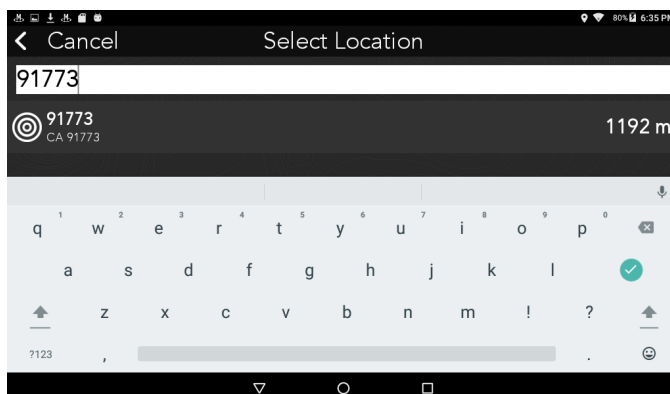

SEARCH LOCATION/NEAR CITY OR ZIP

- Press the option of Near City or Zip.
- Enter the City or U.S. Zip Code.
- Select from the results shown to confirm the area to search around.
- Continue your search by entering an address, keyword or by selecting on of the search categories.

Search.

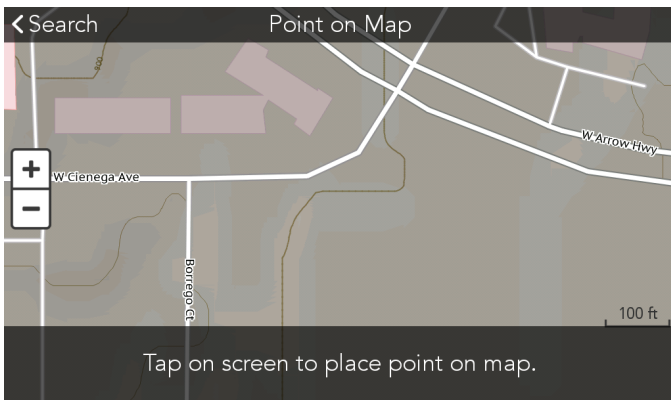

SEARCH LOCATION/NEAR POINT ON MAP

- Press the option for Near Point on Map.
- Tap on the screen to place a point on the map.
- Press OK or Clear Point.
- Continue your search by entering an address, keyword or by selecting one of the search categories.

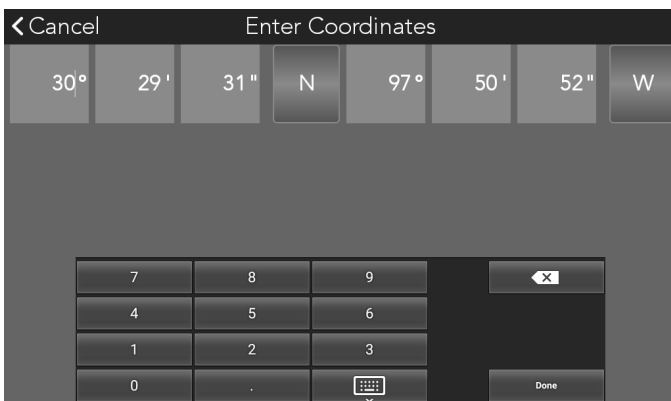

SEARCH LOCATION/NEAR COORDINATES

- Press the option for Near Coordinates.
- Enter the coordinates.
- Continue your search by entering an address, keyword or by selecting one of the search categories.

NOTE: The default coordinate format is in Degrees, Minutes, Seconds. You can change the coordinate format settings in Settings>General

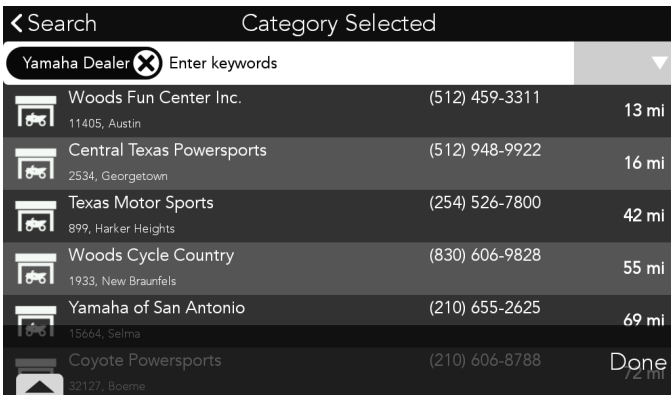

SEARCH RESULT/LIST VIEW

By default search results are displayed in list form.

Select a result from the list or choose **DONE** to view the search results in a Map View.

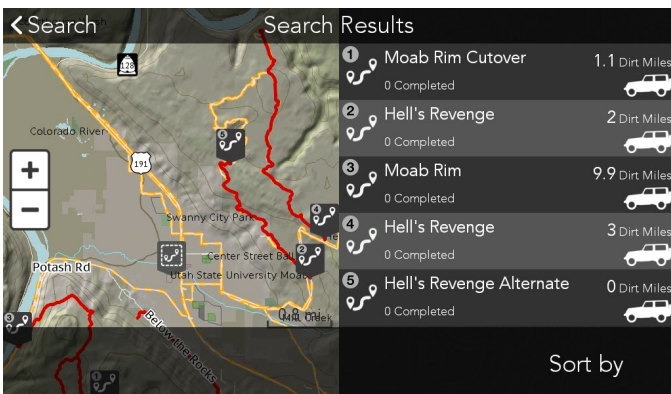

SEARCH RESULT/MAP VIEW

Search results are displayed five at a time with five numbered markers shown on the map and in a corresponding list on the right.

- Select an item from the list or map to open the Info for that item.
- Scroll up on the list to view the next five search results.

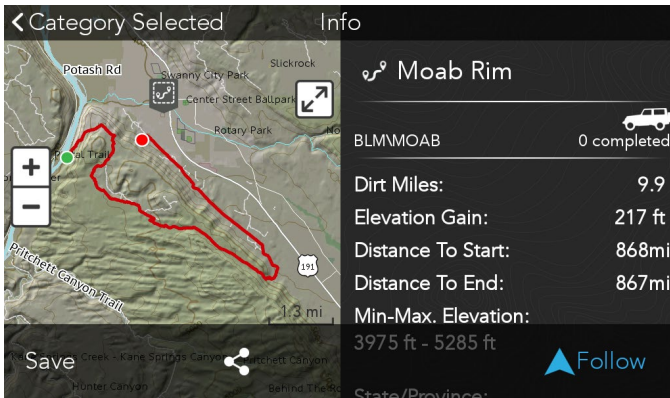

SEARCH RESULT/INFO

The Info screen displays the search result on the map and the detailed info on that item on the right of the screen.

- Choose to Save, Share or Follow/Go.

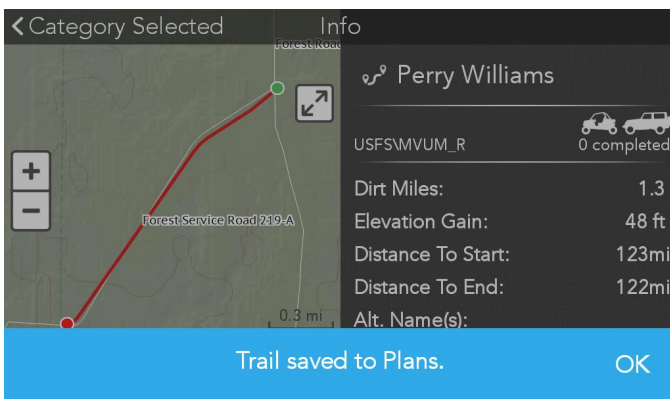

SEARCH RESULT/SAVE

Select **Save** to save the item to your Plans folder.



SEARCH RESULT/SHARE

Select  to post the item to your connected social feeds.

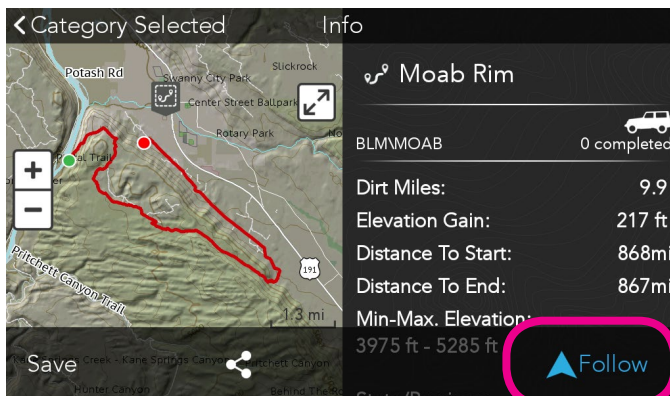

SEARCH RESULT/FOLLOW/GO

- For Points of Interest, select **GO** for directions to the item.
- For Trails, Tracks and Routes, select **FOLLOW**. You will be given guidance to the trail-head. At the trail-head the trail, track or route will be highlighted so that you can follow it.

Map & Navigation.

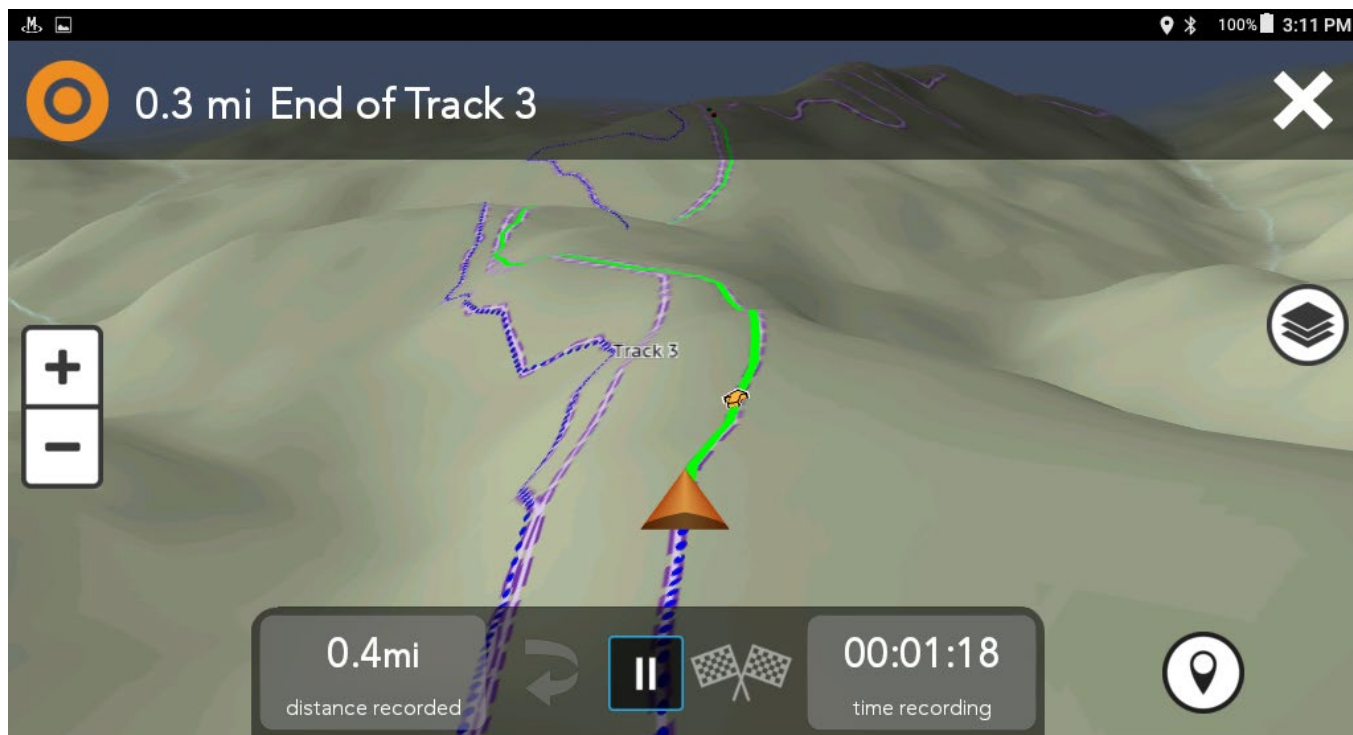

MAP & NAVIGATION OVERVIEW

The map screen consists of a top navigation bar, tracking controls and map controls.

NAVIGATION BAR



The navigation bar appears when you have chosen a destination to navigate to. The navigation bar will give you information such as distance to end or upcoming turns.

TRACKING CONTROLS



Rec/Pause: Tap to pause or resume Tracking.



Backtrack: Follow active Track back to starting point.



Finish: Save your Tracks and details.

00:01:18

time recording

Instruments: There are two instrument boxes to display various data options you want on the map while you navigate or track. To change the data displayed, press on the instrument box you want to change and select from the data options.

MAP CONTROLS



Map Options: View map display settings.



Waypoint: Mark Waypoints while recording a Track.



Zoom: Allows you to zoom in or out on an area of the map

Map & Navigation.

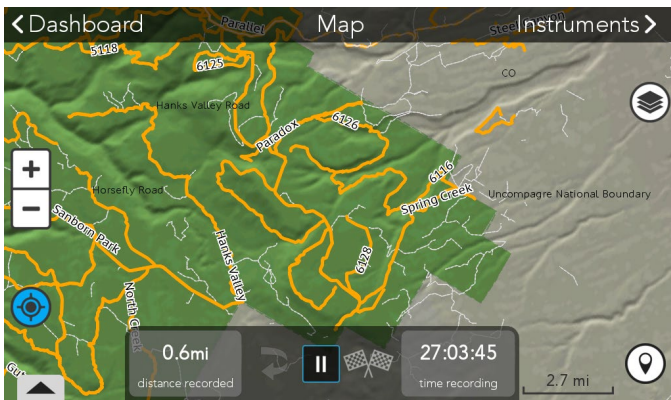

PANNING THE MAP

- Press and drag the map to move/pan to another location.
- Press  to return to your current position.

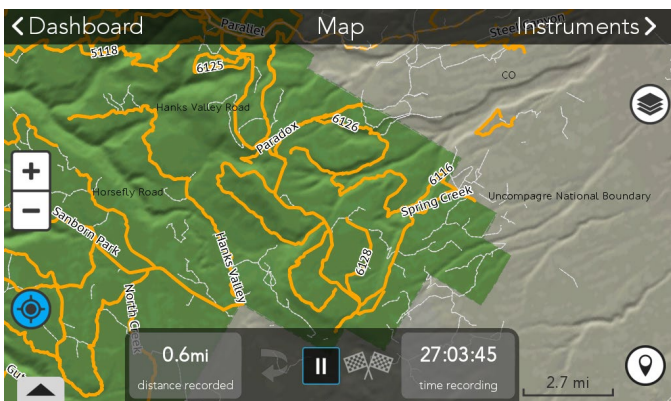

MAP ZOOM

Zoom range is 120ft - 2070mi.

- Press “+” to zoom in closer to ground level.
- Press “-” to zoom out farther from ground level.

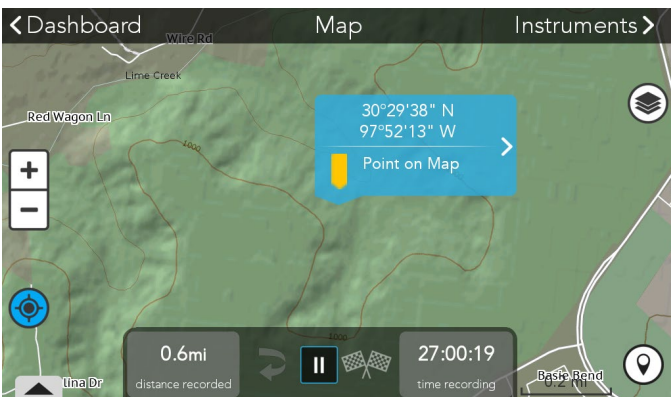

SELECT A POINT ON MAP

- Press and hold any point on the map to open details about an object (trail, track, waypoint, etc.) or area.
- If you select an open area of the map, information about that area will be presented including coordinates for the point and information about nearby cities, trails, waypoints, etc.
- Select the option to Place Waypoint or to GO to that point.

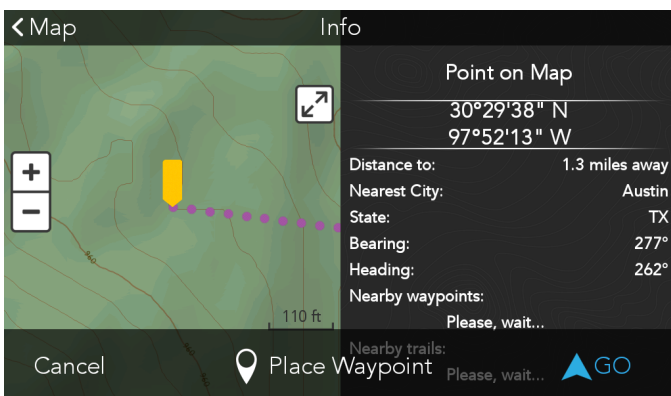

Map & Navigation.

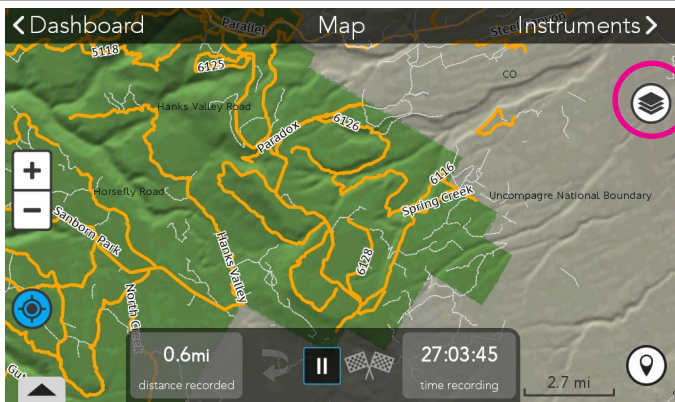

MAP OPTIONS

Press  to open the map options.

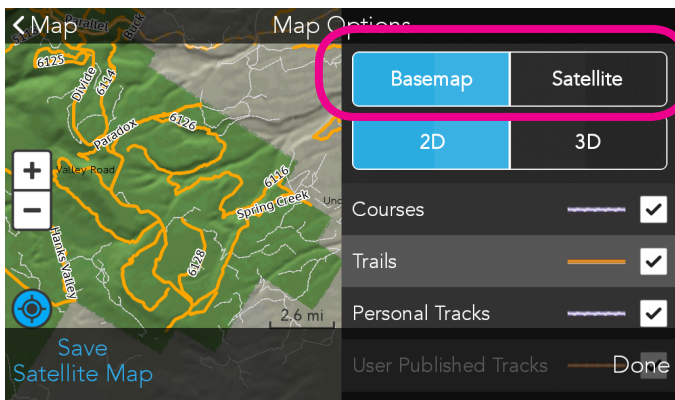

SWITCH THE BASEMAP

Switch between satellite or basemap views.

You must have an active Satellite Imagery subscription to turn on Satellite view.

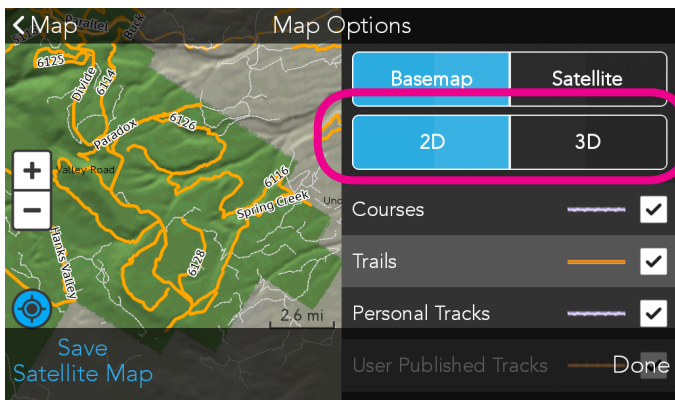

SWITCH 2D/3D VIEWS

Select between a 2D topographic basemap or 3D terrain view basemap.

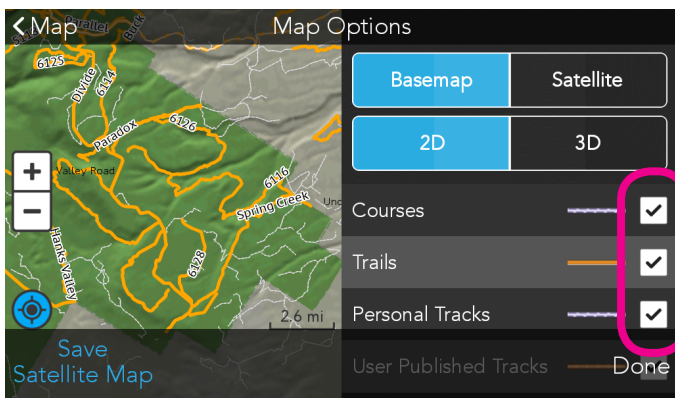

ADDITIONAL MAP OPTIONS

Turn on and off content layers to customize your map view.

Map & Navigation.

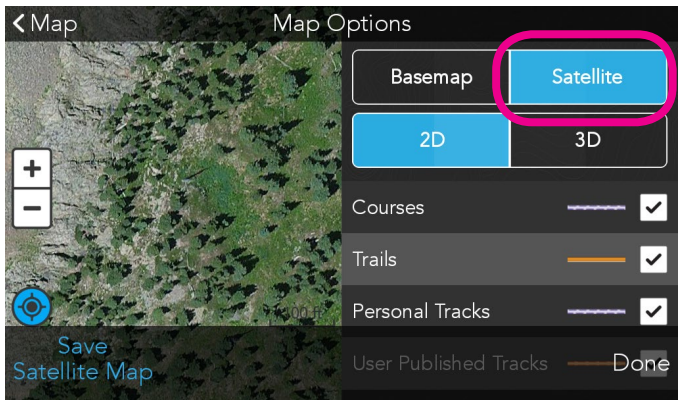

SATELLITE IMAGERY

Satellite Imagery is an optional subscription purchase through Magellan GPS.

To purchase a 1-year subscription for your Yamaha Adventure Pro visit:

<http://www.magellangps.com/Store/Satellite-Imagery/Digital-Globe-Satellite-Imagery>

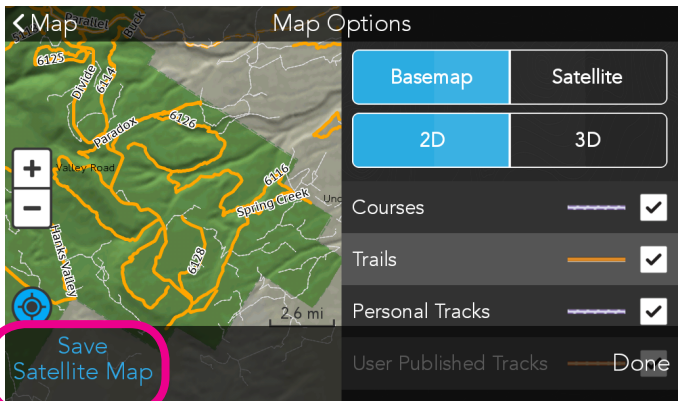

SAVE SATELLITE MAP

Press **Save Satellite Map**

Zoom and pan the map to the area you want to save.

Name the map area.

Press **Save**.

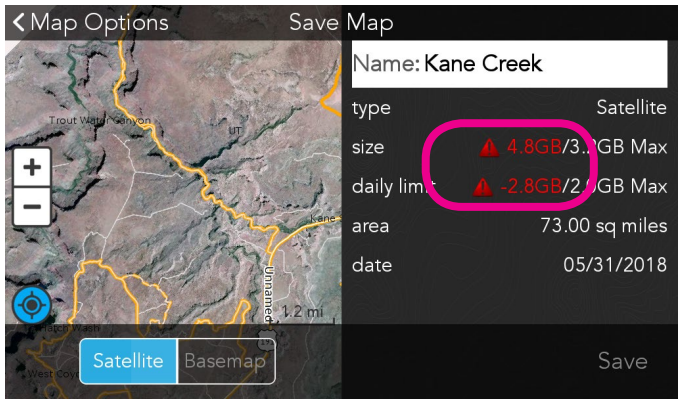

SATELLITE IMAGERY SIZE & DAILY LIMITS

Size: Displays the available space on the GPS. If the area selected exceeds the available space on your GPS the exceeded value will display in red.

Daily Limit: DigitalGlobe, the provider for the satellite imagery, enforces a daily limit for downloaded imagery. If the area that you have selected is over the daily limit size the exceeded amount is displayed in red.

Map & Navigation.

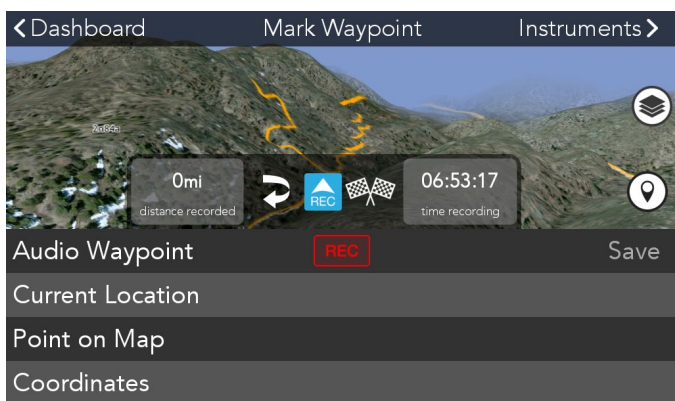
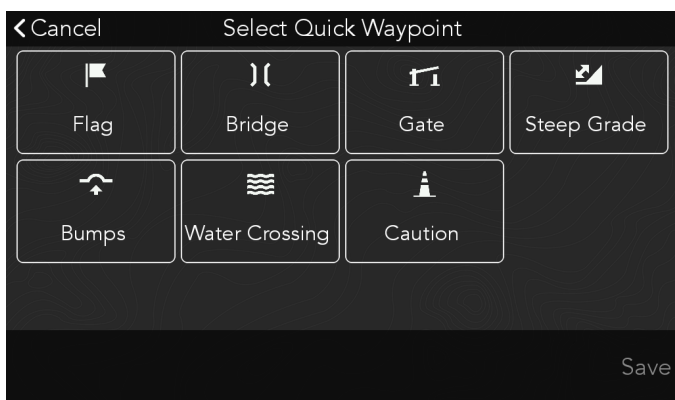

WAYPOINTS

Set waypoints along a trail, track or course to mark important locations.

Waypoints recorded while recording a track or course are Quick Waypoints and are attached to that track in your Log or the course in your course history.

QUICK WAYPOINTS

When recording a track or course you have access to a subset of Quick Waypoint options to mark and keep moving.

DETAIL WAYPOINTS

For more details and options, pause your recording and select . Select to record an audio waypoint, mark the waypoint at your current location, select any point on the map or by entering the coordinates or the waypoint.

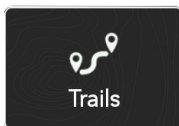

WATER: River, Lake, Stream, Watering Hole, Waterfall, Potable Water, Water Crossing

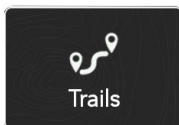

SUPPLIES: Store, Gas, Outfitter

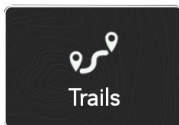

OBSTACLE: Steep Grade, Bumps, Ditch, Tight Spot

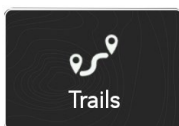

CAUTION: Bridge, Gate, Road Crossing, Closure, Blocked

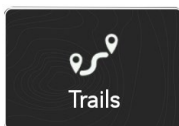

GENERAL: Flag 1, Flag 2, X-Mark, Parking

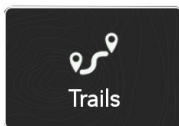

CAMPSITE: Primitive, Tent, Car, RV, Group

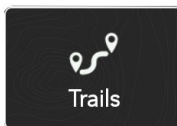

RACING: Turn Left/Right, Bear Left/Right, Sharp Left/Right, Straight, Checkpoint

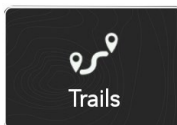

STAY LEFT

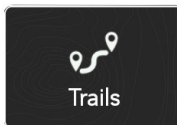

STAY RIGHT

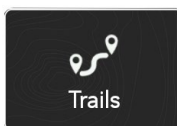

UNKNOWN SIGHTING

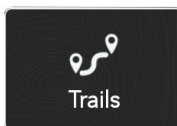

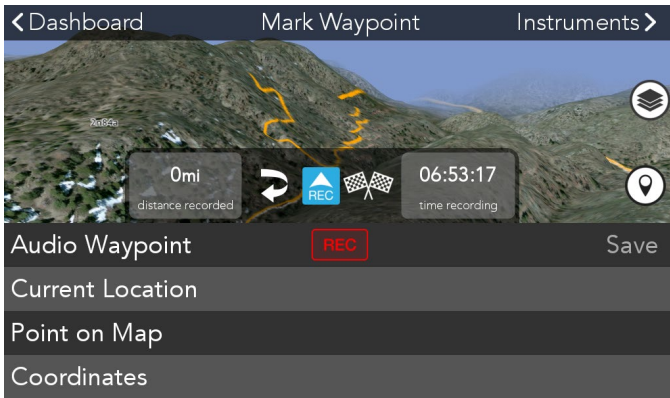

SCENIC SPOT

Map & Navigation.



AUDIO WAYPOINTS

- When Paused, click .
- Next to **Audio Waypoint**, click  to begin recording your audio waypoint.
- Press  to stop the recording.
- Press **SAVE** and complete any additional details you want to capture.

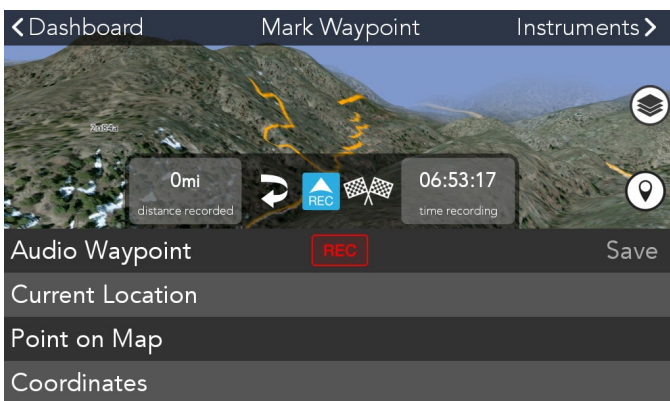

SET WAYPOINT AT CURRENT LOCATION

- When Paused, click .
- Press **Current Location**.
- Select a waypoint type and press **Next**.
- You can optionally enter a name, details, and add photos to waypoints.
- Press **Save**.

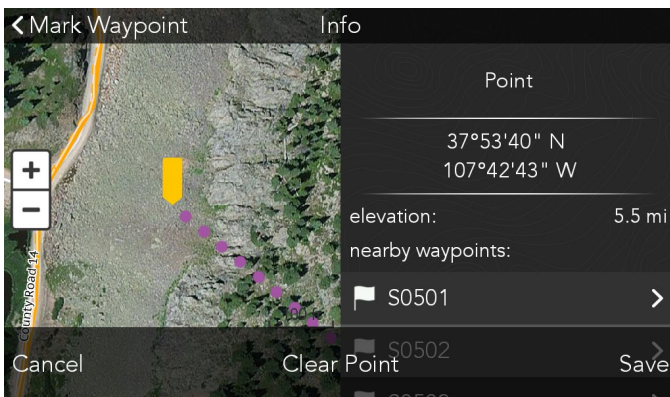

SET WAYPOINT AT POINT ON MAP

- When Paused, click .
- Press **Point on Map**.
- Tap anywhere on the screen to place a point on the map.
- Press **Save** or **Cancel** or you can press **Clear Point** and mark a different location.

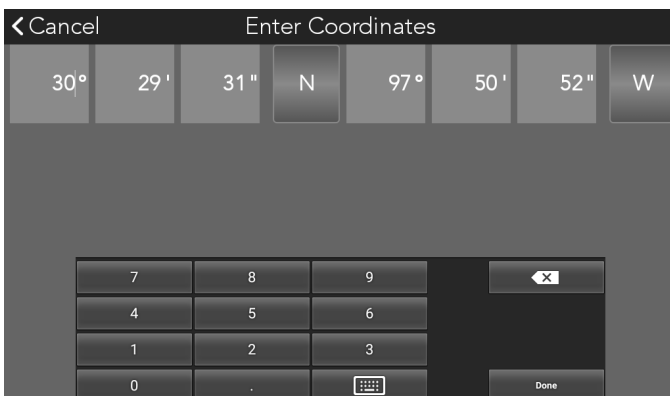

SET WAYPOINT AT COORDINATES

- When Paused, click .
- Press **Coordinates**.
- Enter the coordinates for the waypoint. Press **Done**.
- Press **Save** or **Cancel**.

Map & Navigation.

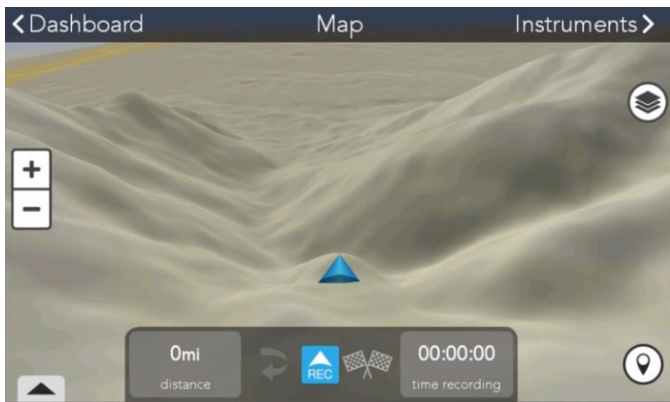

RECORD A TRACK

- Open the map.
- Press  button to start recording a track.

Your active track will display on the map as a line of blue dots following your current position.

ON THE MAP:

Dotted blue line 



PAUSE TRACKING

- Press  to pause a track recording.



RESUME TRACKING

- Press  to resume a track recording.

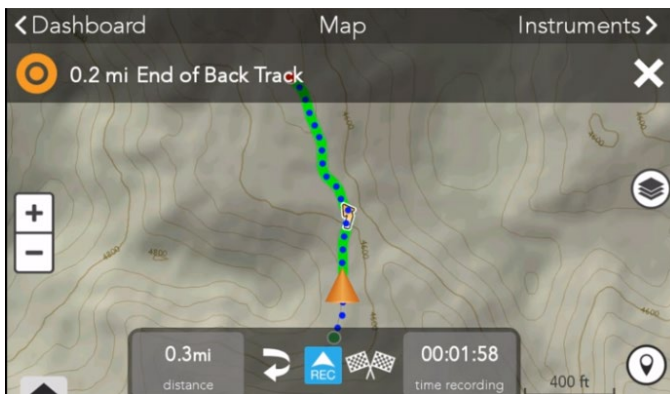

BACKTRACK TO START

Press  to pause a track recording.

- Press 

Your track recording will highlight as a route, guiding you back to the start of your track recording.

Map & Navigation.



FINISH & SAVE A TRACK

- Press to pause a track recording.
- Press to finish the track recording.
- Enter a name for your track.
- Enter any track details that you want to remember about the track and the conditions.
- Press Save. Your Track recording is saved to your Logs.

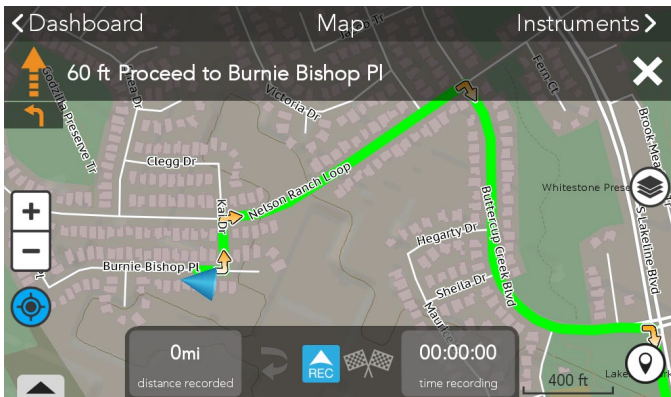
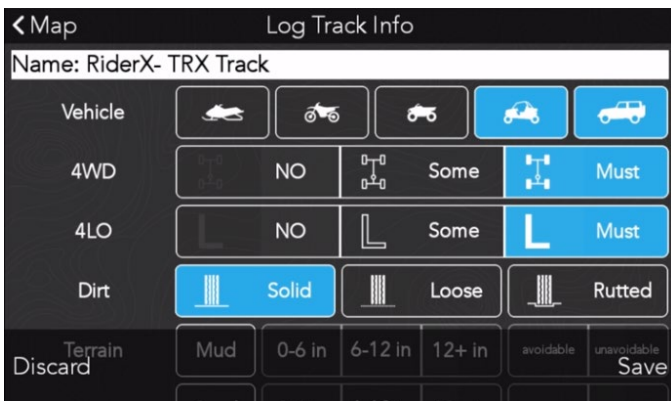

A NOTE ABOUT NAVIGATION

By default setting, your Yamaha Adventure Pro will NOT calculate street navigation directions to a chosen destination. Instead, a straight point-to-destination line will be drawn between your current position and the chosen destination.

You can turn on street navigation in Settings if you plan to use the Yamaha Adventure Pro in a street legal vehicle.



TURN ON STREET NAVIGATION

- On the Menu Bar, select Settings.
- Select Navigation.
- Check the box for Street Navigation to turn it ON.

Map & Navigation.

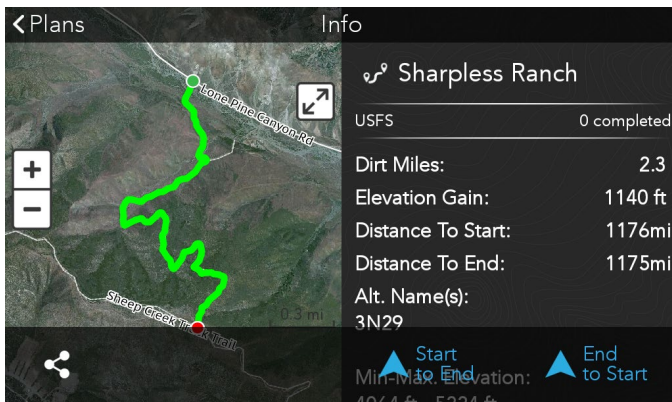

HOW TO FOLLOW A TRAIL

- Select a trail from a search result, your plans folder or by selecting one on the map.
- In the trail info window, select Follow.
- Choose the trailhead that you want to start at.
- A straight, point-to-destination line will be drawn from your current position to the selected trailhead.
- You will be notified of your arrival at the trailhead.
- The trail will be highlighted in bright green and a yellow guidance arrow leads the way just ahead of your current position.

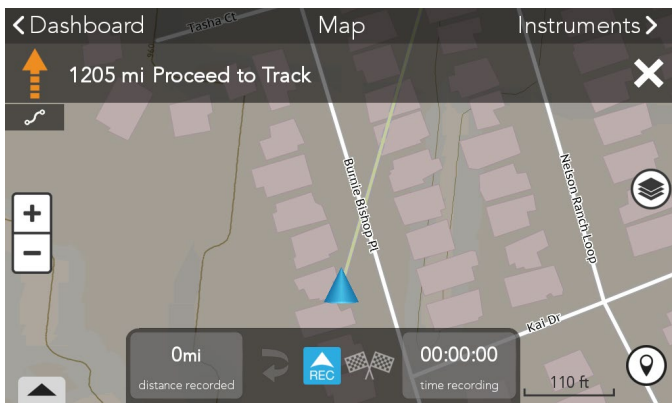

HOW TO FOLLOW A TRACK

- Select a track from a search result, your Logs or Plans folder, or by selecting one on the map.
- In the track info window, select Follow.
- Choose the trailhead you want to start at.
- A straight, point-to-destination line will be drawn from your current position to the selected trailhead.
- You will be notified of your arrival at the trailhead.
- The trail will be highlighted in bright green and a yellow guidance arrow leads the way just ahead of your current position.

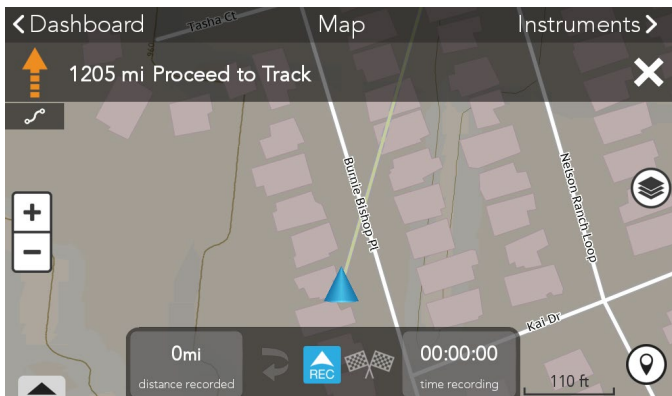

Map & Navigation.

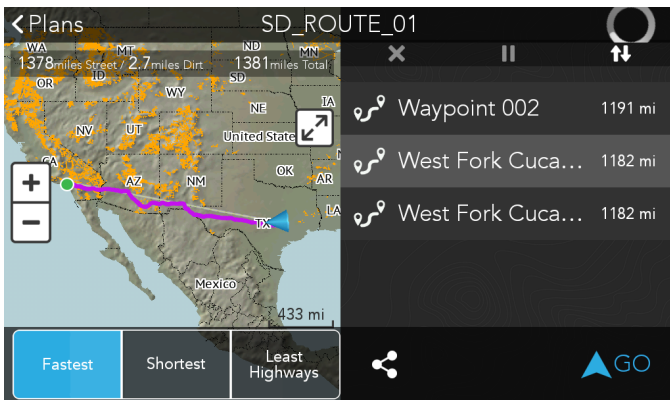

HOW TO FOLLOW A CUSTOM ROUTE

- Select a route from your Plans folder.
- In the Route info window, select Follow.
- Choose the trailhead you want to start at.
- A straight, point-to-destination line will be drawn from your current position to the selected trailhead.
- You will be notified of your arrival at the trailhead.
- The trail will be highlighted in bright green and a yellow guidance arrow leads the way just ahead of your current position.

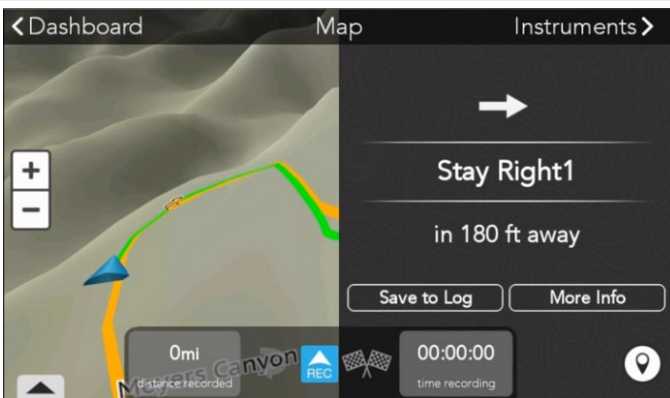
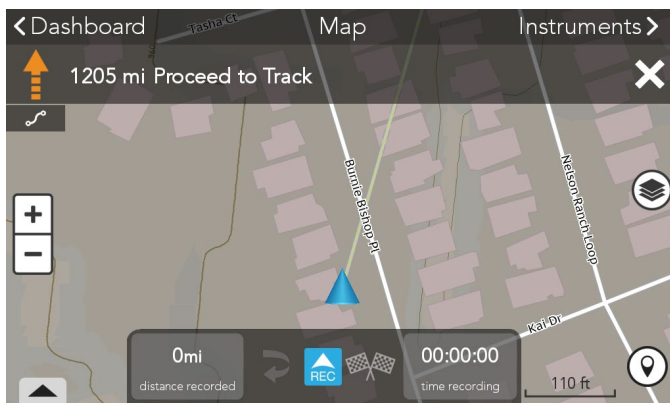

WAYPOINT ALERTS

When you are following a track or course that have waypoints attached to them you will see a waypoint pop-up alert as you approach the waypoint.

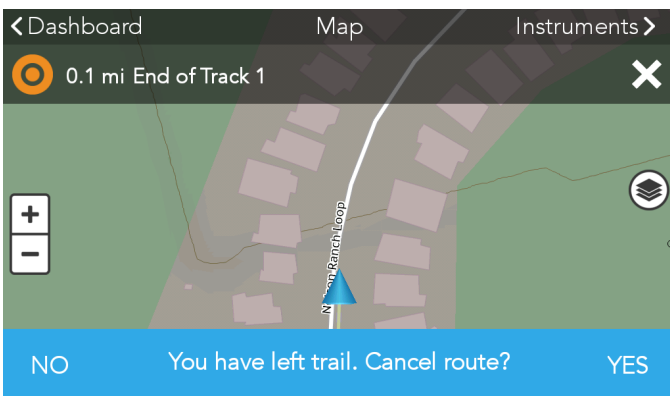

OFF-TRACK ALERT

While following a track, trail, course or route if you deviate from the highlighted path an off-track alert will notify you have left the track and ask if you want to continue following it.

Select YES to continue following.

Select NO to cancel the route.

Timing Mode.



TIMING MODE.

This function gives you the ability to measure your driving time automatically using the GPS signal, record your history with in-vehicle information for your review, and share on YamahaAdventurePro.com.

You can either create your own Course by driving through the Course and setting the start/finish location, or convert a Track recording from your log into a Course by selecting the edit Track button and selecting Create Course.

SESSION HISTORY:

View timing measurements and vehicle performance data from past Sessions.

STORED COURSES:

Select from past or converted Courses and start a **New Session** to record new timing measurements and vehicle performance data.

CREATE NEW COURSE:

Run and record to create a new Course.

Timing Mode.

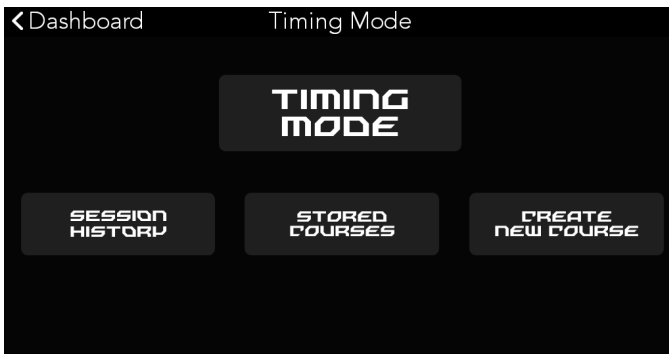

CREATE A NEW COURSE.

Tap **Create New Course** when you get to the location where you want to set as the Starting Line. Tap **Set Starting Line** and begin driving through the Course you want to create.

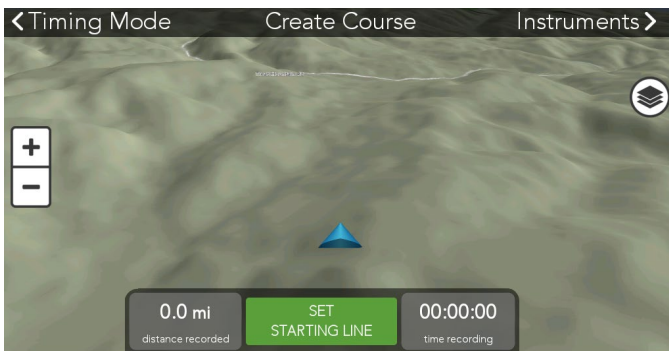

LOOP COURSE

If you are creating a Loop Course, the system will automatically recognize the Finish Line when you return to the Starting Line.

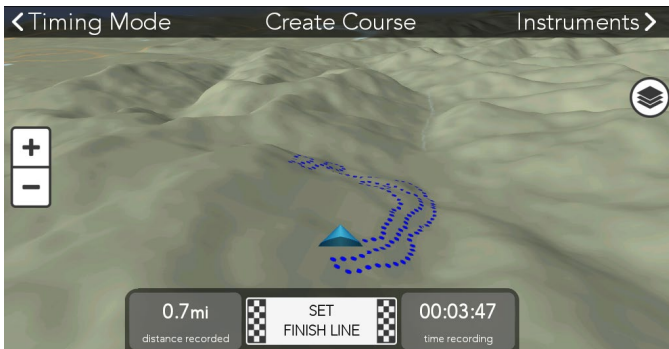

SPRINT COURSE

If you want to create a one-way Sprint Course, tap **Set Finish Line** at the location where you want to set as Finish Line. > Save the information.

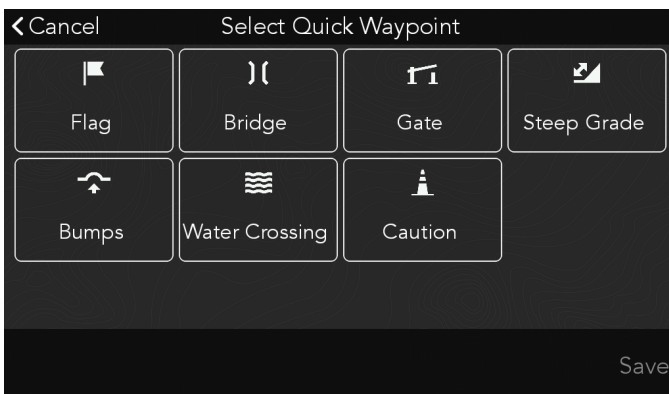

COURSE WAYPOINTS

To create waypoints for your Course tap  to mark any waypoints you want to view during your Sessions.

Timing Mode.



START A NEW SESSION

Tap **Stored Courses** > Select a Course you want to race > Tap **New Session** > Tap **Start** > measurements will start automatically when you get to the Starting Line.

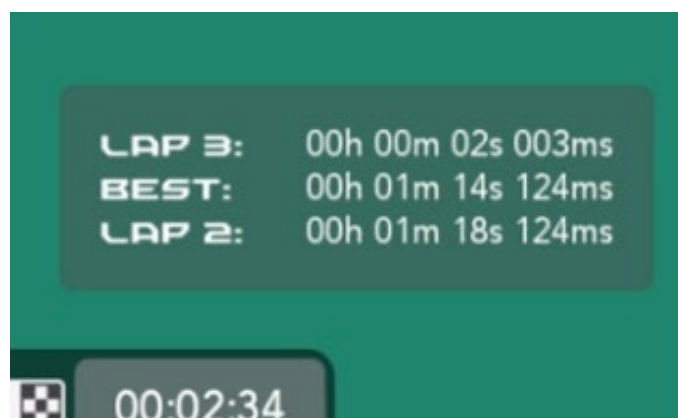

LAPS

Laps are the number of times you go around a Loop Course.

After your first time around the course your first lap time is displayed on the map above your current lap time.

After two or more laps are complete the window will display your current, best and average lap times.



RUNS

Runs are the number of attempts made on a Sprint Course.



FINISH A SESSION

On Loop Courses you must tap the Checkered Flag button to finish the Session and save your Session measurements and vehicle performance data.

For Sprint Courses the Finish Line is automatically detected as you cross the marked Finish Line. Save your Session measurements and vehicle performance data.

Timing Mode.

< Timing Mode Session History

SESSION	COURSE	DATE
Session5	Course 0228	04/17/2018
0228_Session5	Course 0228	02/28/2018
Session4	Rear Admiral Philip's Loop	02/20/2018
Session3	Course1	02/13/2018
Session2	linear2	02/09/2018
Session1	Course9	02/09/2018
Session1linear	Course 5linear	02/09/2018

CLEAR HISTORY

SESSION HISTORY

- Session History shows a chronological listing of your recorded sessions.
- Press **Session History**.
- Select a Session you want to review.

< Timing Mode Session History

SESSION	COURSE	DATE	
Session5	Course 0228	04/17/2018	<input type="checkbox"/>
0228_Session5	Course 0228	02/28/2018	<input type="checkbox"/>
Session4	Rear Admiral Philip's Loop	02/20/2018	<input type="checkbox"/>
Session3	Course1	02/13/2018	<input type="checkbox"/>
Session2	linear2	02/09/2018	<input type="checkbox"/>
Session1	Course9	02/09/2018	<input type="checkbox"/>
Session1linear	Course 5linear	02/09/2018	<input type="checkbox"/>

CLEAR HISTORY

CLEAR HISTORY

- Press **Clear History**.
- Check the box for any sessions you want to delete.
- Select **OK** or **Cancel** when asked if you want to "Delete Selected Entries?"

< Sessions Info

SESSION	TIME
Lap 1	00:01:33.6
Lap 2	00:03:14.3
Lap 3	00:03:16.4
Lap 4	00:03:15.4
Lap 5	00:03:14.4
Lap 6	00:03:16.4
Lap 7	00:03:14.4
Lap 8	00:03:15.4

Info

Conditions: Sunny, Sunny, Cloudy, Windy
Terrain: Rocky, Ruddy, Icy, Snow

Vehicle type:

GPS Speed:

REVIEW LAPS AND VEHICLE DATA

The Session Detail screen shows the number of laps or runs recorded for that session with conditions and statistics for the overall session and individual laps. Tap on any lap to see that lap color highlighted in the vehicle data graphs. Scroll through the vehicle data graphs to view GPS speed, Engine Speed (EG Speed),

< Info Choose Social Media

	Twitter	>
	Facebook	>

SESSION SHARING

You can share your sessions when you are connected to Wi-Fi. To share a session tap

Settings.

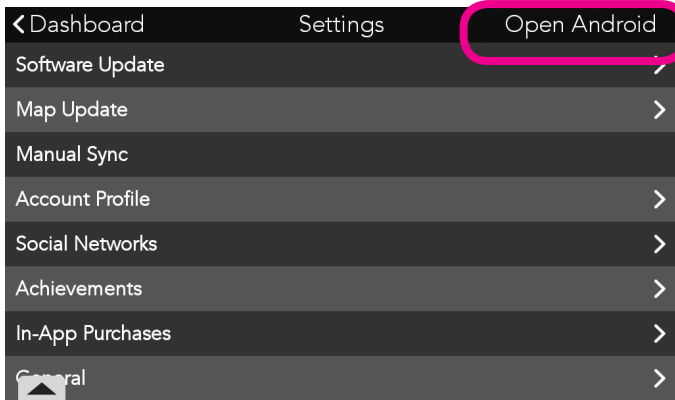

OPEN ANDROID

Select this option to exit the Yamaha Adventure Pro software into the Android operating system. To re-enter the Yamaha Adventure Pro software, select the Yamaha Adventure Pro app icon.

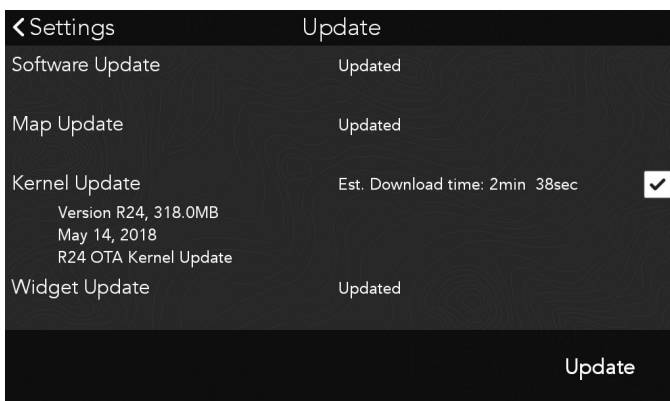

SOFTWARE UPDATE

- Make sure you are connected to Wi-Fi.
- Press **Updates**.
- Your Adventure Pro will display any available updates for the software, map, kernel or widget. If everything is up to date it will show Updated.

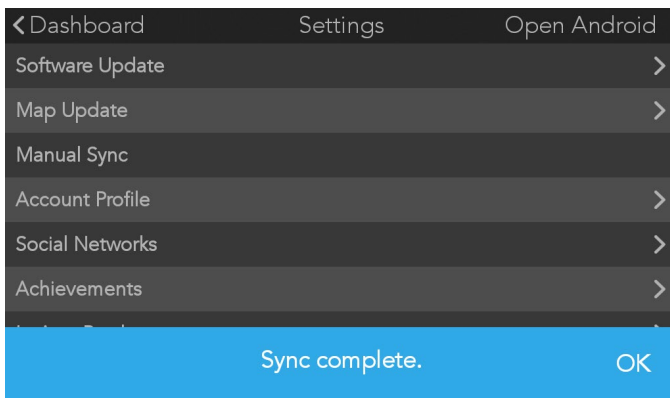

MANUAL SYNC

- Make sure you are connected to Wi-Fi.
- Press **Manual Sync**.
- Press OK when asked to Sync with YamahaAdventurePro.com.
- Press OK when the Sync Complete message appears.
- Your data is now in sync with your online account.

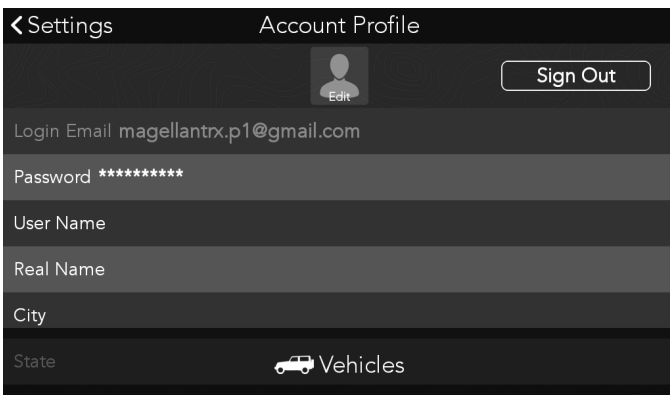

ACCOUNT PROFILE/CREATE ACCOUNT

- Make sure you are connected to Wi-Fi.
- Press **Account Profile**.
- If you have not previously created an account you will need to press **Create Account**.
- Enter an email and password and other optional details.
- Press **Create Account**.

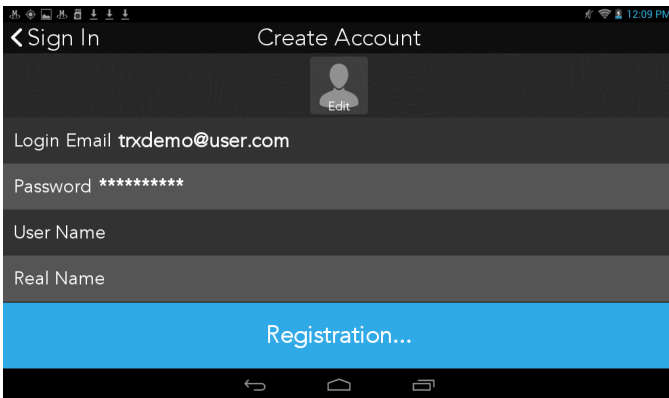

PRODUCT REGISTRATION

Your GPS is automatically registered when you create your account.

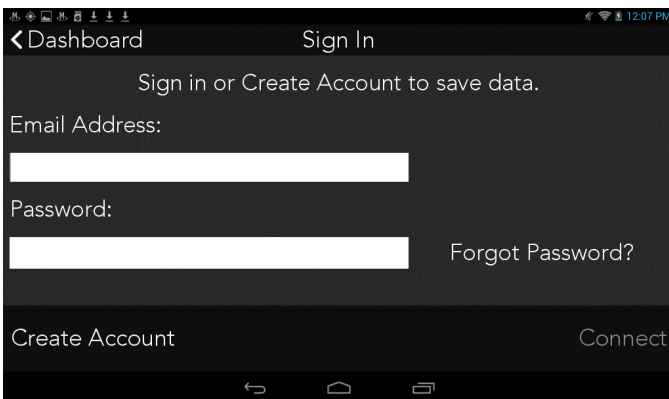

ACCOUNT PROFILE/SIGN IN

- Make sure you are connected to Wi-Fi.
- Press **Account Profile**.
- Enter your email and password.
- Press **Connect**.

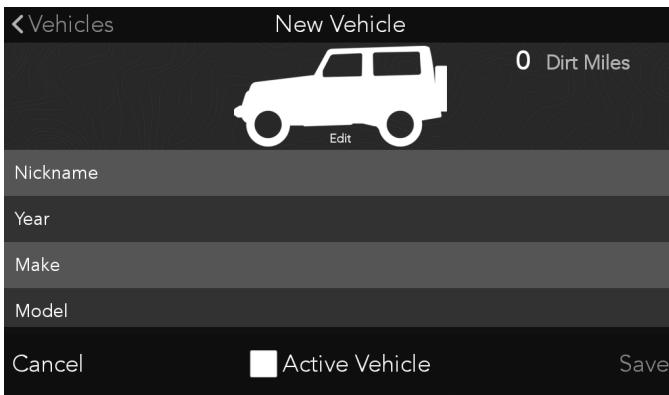

VEHICLE PROFILE

- To change or add a vehicle profile, press **Account Profile** and then press **Vehicle Profile**.
- Enter a nickname, Year, Make, Model.
- Select **Edit** to add a photo of your vehicle.
- Select **Active Vehicle**.
- Select **Save**.

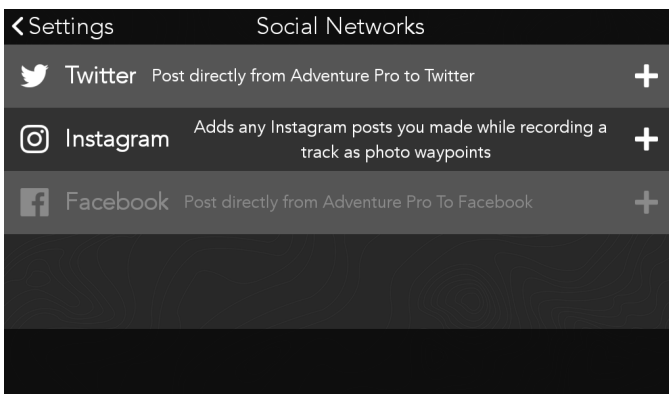

SOCIAL NETWORKS

- Press **Social Networks**.
- Press the + symbol next to any of the social networks that you want to link to your Adventure Pro account.

Settings.



LINK YOUR TWITTER ACCOUNT

- Press **Social Networks**.

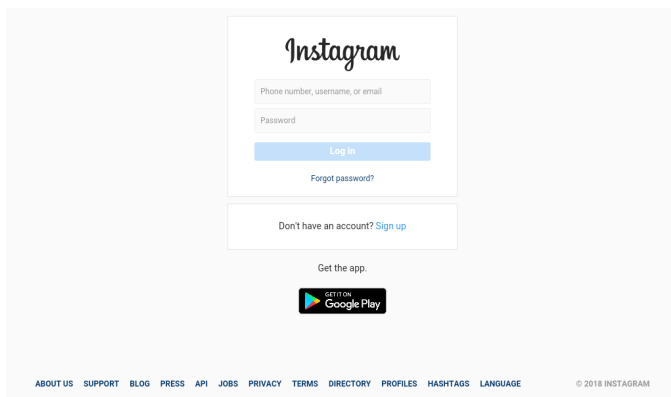

LINK YOUR INSTAGRAM ACCOUNT

- Press **Social Networks**.



LINK YOUR FACEBOOK ACCOUNT

- Press **Social Networks**.

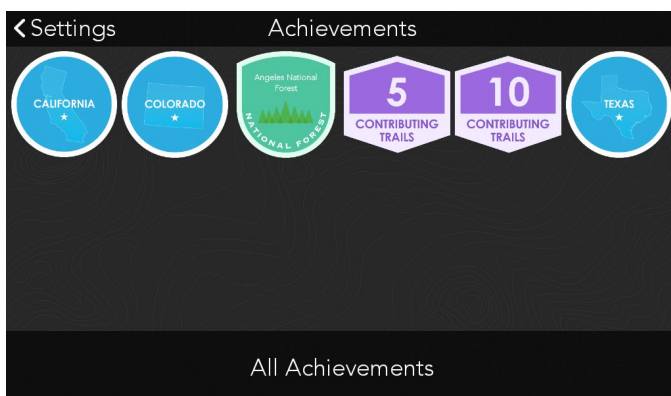

ACHIEVEMENTS

Achievement badges are earned for locations visited and usage milestones.

To view your current achievements press **Achievements**.

To view all achievement badges press **All Achievements**.

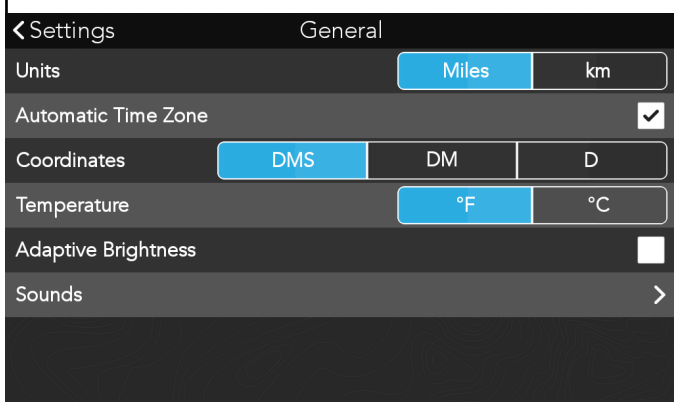

GENERAL

Set preferences for units of measurement, coordinate format, temperature, adaptive screen brightness and sound settings.

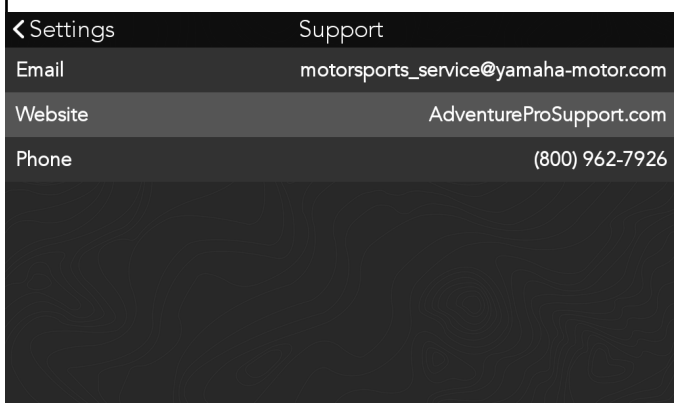

SUPPORT

View contact information to get support for your Yamaha Adventure Pro.

Press the support URL to open the support pages for Adventure Pro to search and read more how to articles and video tutorials.

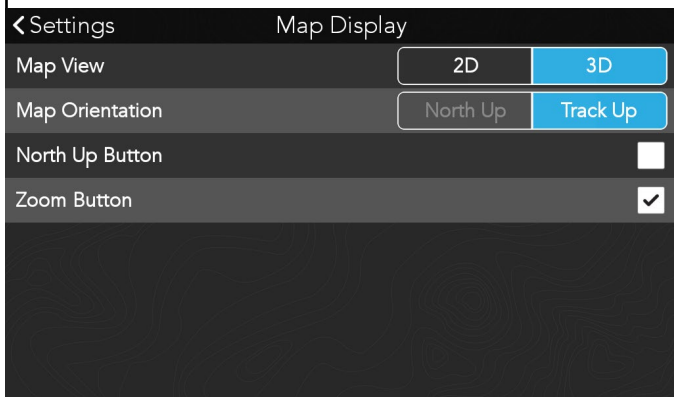

MAP DISPLAY

Set preferences for 2D/3D, map orientation and to turn ON/OFF the north up and zoom buttons on the map screen.



NAVIGATION

By default, the ability get turn by turn navigation on streets is turned off. If you choose to use your Yamaha Adventure Pro GPS in a street-legal vehicle, you can turn ON Street Navigation to get turn by turn street directions to your destination.

Press **Navigation**.

Turn ON/OFF street navigation.

Settings.



MAP SAVE

Map Save allows you to view and manage any saved satellite imagery map areas. You must have a current satellite imagery subscription to save imagery.

Satellite Map Area Auto Save will automatically save the imagery surrounding any trails, tracks or points of interest saved into your Plans folder.

To manage any downloaded imagery press **Saved Maps**.

Choose any saved map areas to view details or to delete them to free space.

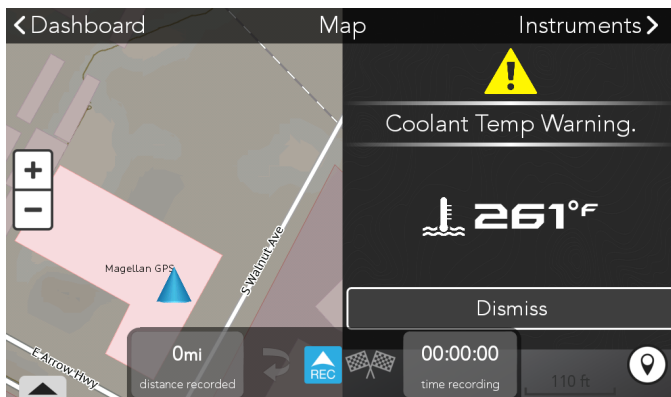
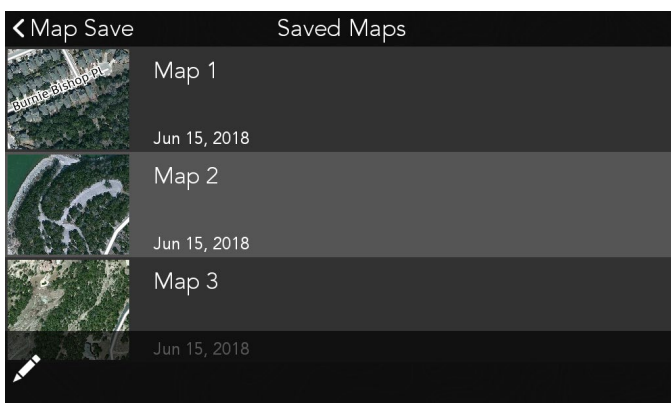

SERVICE ALERTS

Your Adventure Pro will prompt you with any service alerts or fault codes that require your attention.

- Press Dismiss to close the alert dialog box.

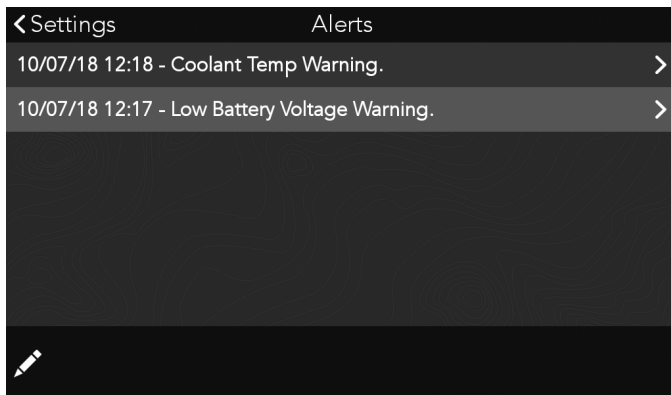

REVIEW OR CLEAR SERVICE ALERTS

To review service alerts go to Settings and open the Service Alerts option.

Any service alerts or fault codes would be listed by date and title and can be opened to view additional details.

To clear service alerts, press the edit button in the Alerts list and check the boxes for the alerts that you want to clear.

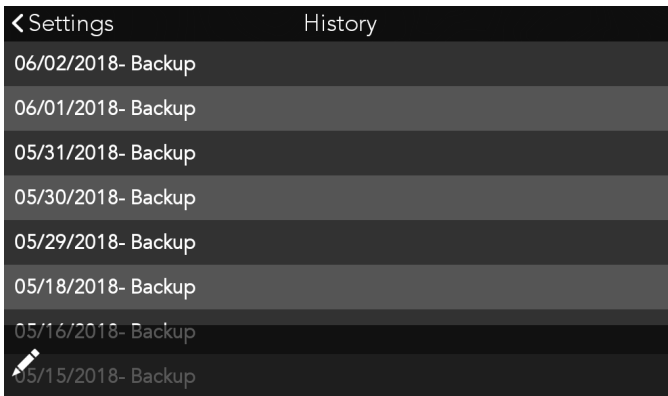

HISTORY

Restored Track Logs by date.



WI-FI

Connect to Wi-Fi networks.

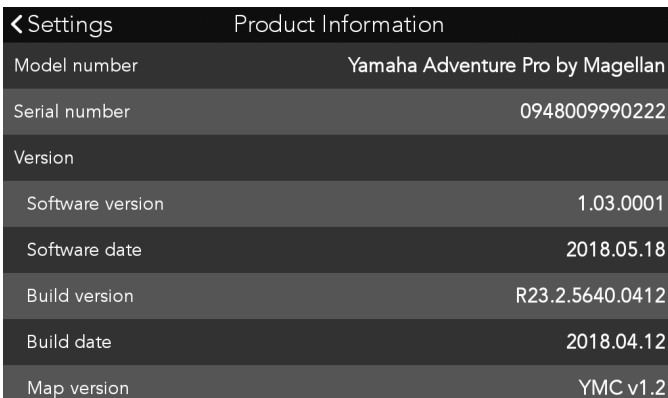

PRODUCT INFORMATION

Hardware and software model and version numbers. End-User License Agreement.

Camera.

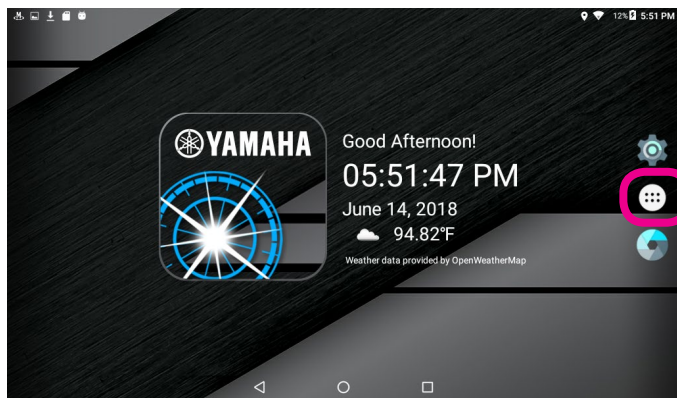

OPEN ANDROID

From the Yamaha Adventure Pro software:

1. Select Settings from the menu bar.
2. Press Open Android in the top right of the Settings screen.
3. Press the Apps button in the right hand menu.

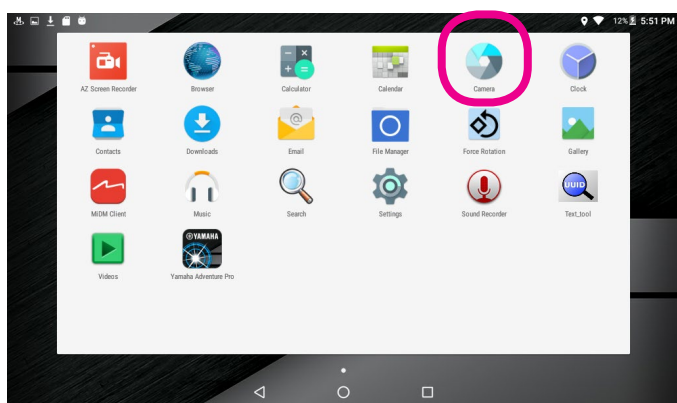

OPEN THE CAMERA APP

Select the Camera app from the Android Apps menu.

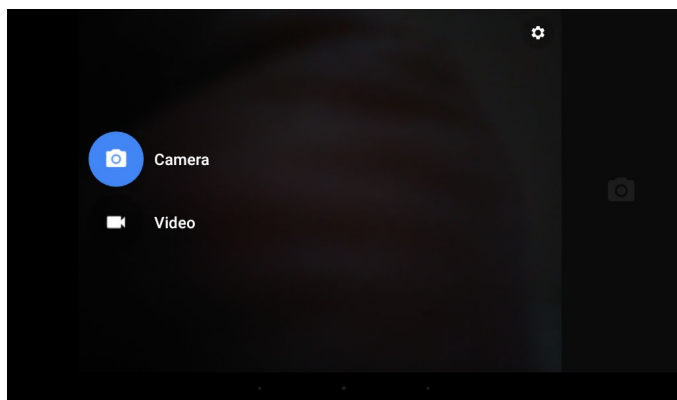

OPEN CAMERA SETTINGS

From the left of the screen, swipe to the right. This will open the option to switch from photo to video and also display the camera settings in the top right of the screen.

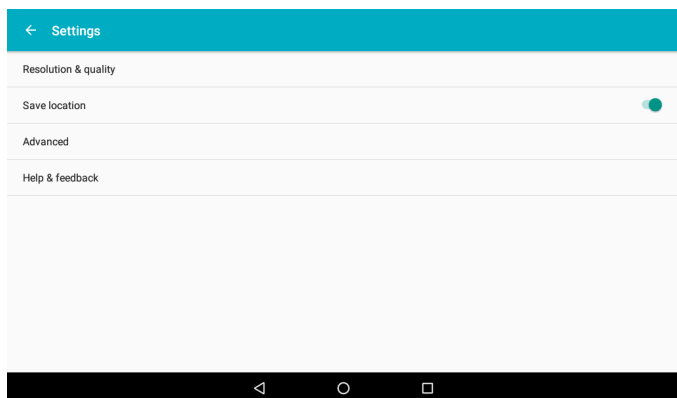

CAMERA SETTINGS

Choose from the Settings options to set the resolution and quality of your photos and videos, and also choose if you want location information saved with your photos.

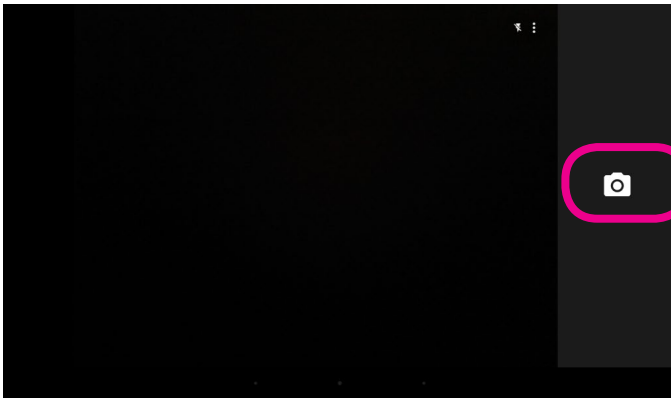

TAKING PHOTOS

Press the camera button to take a photo.

Press the menu button (⋮) to access flash, HDR and timer settings.

After you take a photo an icon will appear at the top of the screen to open your photo gallery.

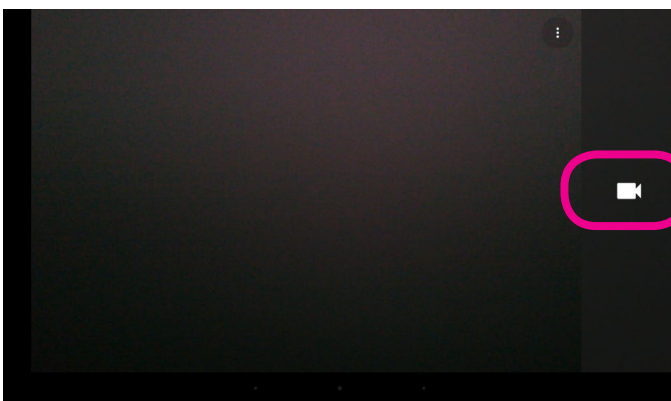

TAKING VIDEO

Press the video camera icon to begin recording.

Press the stop button to end recording.

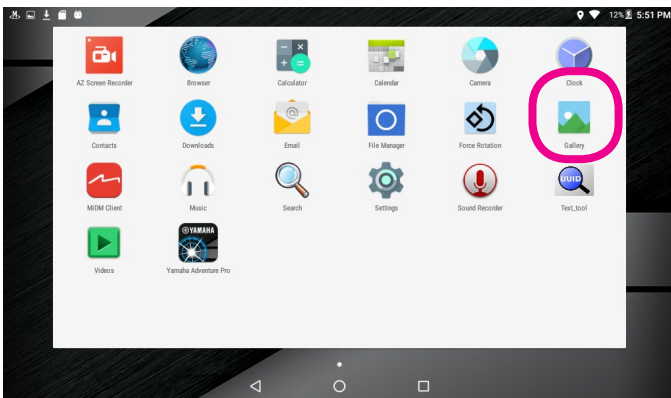

VIEW PHOTOS & VIDEOS

Select the Gallery app from the Android Apps menu.

Need Technical Support?

Go to **AdventureProSupport.com** for online troubleshooting and feedback.

If you can't find a solution there, e-mail us at **motorsports_service@yamaha-motor.com**
or call Yamaha Motor Corporation USA Customer Relations Department at **1-800-962-7926**.



Yamaha Motor Corporation U.S.A.
6555 Katella Ave. | Cypress, CA 90630 USA

www.yamahaoutdoors.com

© 2017 MiTAC International Corporation. The Magellan logo and Magellan are registered trademarks of MiTAC International Corporation, and OneTouch is a trademark of MiTAC International Corporation and are used under license by MiTAC Digital Corporation. All rights reserved. All other trademarks and registered trademarks are property of their respective owners.